

AgGPS™ 114

Operation Manual

Part Number: 38201-00

Revision: A

Date: March 2000

*Trimble Navigation
Precision Agricultural Systems
9290 Bond Street, Suite 102
Overland Park, KS 66214
U.S.A.
+1-913-495-2700 International & North America
FAX: +1-913-495-2750
precision_ag@trimble.com*

*Trimble Navigation Limited
645 North Mary Avenue
Post Office Box 3642
Sunnyvale, CA 94088-3642
U.S.A.
+1-408-481-8000 International & North America
FAX: +1-408-481-7744
www.trimble.com*

*Trimble Navigation Europe Limited
Trimble House, Meridian Office Park
Osborn Way, Hook
Hampshire RG27 9HX
ENGLAND
+44-1256-760-150
FAX: +44-1256-760-148*

*Trimble Navigation Singapore PTE Limited
79 Anson Road
#05-02
Singapore 079906
SINGAPORE
+65-325-5668
FAX: +65-225-9989*

*Trimble Japan K.K.
Sumitomo Hamamatsu-cho, Building 10F
1-18-16 Hamamatsu-cho Minato-ku
Tokyo 105
JAPAN
+81-3-5472-0880
FAX: +81-3-5472-2326*

*Trimble Navigation New Zealand Limited
11 Birmingham Drive
P.O. Box 8729 Riccarton
Christchurch
NEW ZEALAND
+64-3-339-1400
FAX: +64-3-339-1417*

Copyrights

© 2000 Trimble Navigation Limited. All rights reserved. No part of this manual may be copied, photocopied, reproduced, translated, or reduced to any electronic medium or machine-readable form without prior written consent from Trimble Navigation Limited.

Printed in the United States of America. Printed on recycled paper.

Release Notice

This is the March 2000 release (Revision A) of the *AgGPS 114 Operation Manual*, part number 38201-00.

Trademarks

Trimble and the Trimble logo are trademarks of Trimble Navigation Limited, registered in the United States and other countries.

AgGPS, AgRemote, The Choice, and TSIP are trademarks of Trimble Navigation Limited.

Microsoft, MS-DOS, Windows, Windows 95, and Windows NT are registered trademarks or trademarks of Microsoft Corporation. LandStar is a trademark and a service mark of Racal NCS, Inc. Intel is a trademark of Intel Corporation. All other brand names are trademarks of their respective holders.

Disclaimer of Warranty

EXCEPT AS INDICATED IN "LIMITED WARRANTY" HEREIN, TRIMBLE HARDWARE, SOFTWARE, FIRMWARE AND DOCUMENTATION IS PROVIDED "AS IS" AND WITHOUT EXPRESS OR LIMITED WARRANTY OF ANY KIND BY EITHER TRIMBLE NAVIGATION LIMITED OR ANYONE WHO HAS BEEN INVOLVED IN ITS CREATION, PRODUCTION, OR DISTRIBUTION INCLUDING BUT NOT LIMITED TO THE IMPLIED WARRANTIES OF MERCHANTABILITY AND FITNESS FOR A PARTICULAR PURPOSE. THE ENTIRE RISK, AS TO THE QUALITY AND PERFORMANCE OF THE TRIMBLE HARDWARE, SOFTWARE, FIRMWARE AND DOCUMENTATION, IS WITH YOU. SOME STATES DO NOT ALLOW THE EXCLUSION OF IMPLIED WARRANTIES, SO THE ABOVE EXCLUSION MAY NOT APPLY TO YOU.

Limitation of Liability

IN NO EVENT WILL TRIMBLE NAVIGATION LIMITED OR ANY PERSON INVOLVED IN THE CREATION, PRODUCTION, OR DISTRIBUTION OF THE TRIMBLE SOFTWARE BE LIABLE TO YOU ON ACCOUNT OF ANY CLAIM FOR ANY DAMAGES, INCLUDING ANY LOST PROFITS, LOST SAVINGS, OR OTHER SPECIAL, INCIDENTAL, CONSEQUENTIAL, OR EXEMPLARY DAMAGES, INCLUDING BUT NOT LIMITED TO ANY DAMAGES ASSESSED AGAINST OR PAID BY YOU TO ANY THIRD PARTY, ARISING OUT OF THE USE, LIABILITY TO USE, QUALITY OR PERFORMANCE OF SUCH TRIMBLE SOFTWARE AND DOCUMENTATION, EVEN IF TRIMBLE NAVIGATION LIMITED OR ANY SUCH PERSON OR ENTITY HAS BEEN ADVISED OF THE POSSIBILITY OF DAMAGES, OR FOR ANY CLAIM BY ANY OTHER PARTY. SOME STATES DO NOT ALLOW THE LIMITATION OR EXCLUSION OF LIABILITY FOR INCIDENTAL OR CONSEQUENTIAL DAMAGES SO, THE ABOVE LIMITATIONS MAY NOT APPLY TO YOU.

Software and Firmware Limited Warranty

Trimble Navigation Limited warrants that Software and Firmware products will substantially conform to the published specifications provided it is used with the Trimble products, computer products, and operating system for which it was designed. For a period of ninety (90) days, commencing thirty (30) days after shipment from Trimble, Trimble also warrants that the magnetic media on which Software and Firmware are distributed and the documentation are free from defects in materials and workmanship. During the ninety (90) day warranty period, Trimble will replace defective media or documentation, or correct substantial program errors at no charge. If Trimble is unable to replace defective media or documentation, or correct program errors, Trimble will refund the price paid for The Software. These are your sole remedies for any breach in warranty.

Hardware Limited Warranty

Trimble Navigation Limited products are warranted against defects in material and workmanship for a period of 15 months. The warranty period shall commence thirty (30) days after shipment from Trimble's factory. Warranty service will be provided at a designated Trimble Service Center. Trimble will at its option either repair or replace products that prove to be defective. The Customer shall pay all shipping charges for products returned to Trimble for warranty service. Trimble shall pay all shipping charges for the return of products to the Customer.

The above warranty shall not apply to defects resulting from:

1. Improper or inadequate maintenance by the buyer
2. Buyer-supplied software or interfacing
3. Unauthorized modification or misuse
4. Operation outside of the environmental specifications of the product
5. Improper installation, where applicable
6. Lightning or other electrical discharge
7. Fresh or salt water immersion or spray
8. Normal wear and tear on consumable parts (for example, batteries)

No other warranty is expressed or implied. Trimble Navigation Limited specifically disclaims the implied warranties of fitness for a particular purpose and merchantability.

Contents

About This Manual

Scope and Audiencexv
Organizationxvi
Other Informationxvii
World Wide Web (WWW) Sitexvii
Technical Assistancexviii
Reader Comment Form.xix
Document Conventions.xix
Warnings, Cautions, Notes, and Tipsxx

1 Overview

1.1 Differential GPS Positioning1-3
1.1.1 Sources of GPS Error1-3
1.1.2 DGPS Accuracy1-4
1.2 Measuring GPS Accuracy1-6
1.2.1 Receiving Satellite DGPS1-6
1.3 Standard Features.1-8
1.4 Receiver Enhancements1-9
1.4.1 Fast Rate (P/N 33176-10)1-9
1.4.2 Everest Technology (P/N 33176-40)1-9
1.5 Application Options1-10
1.5.1 Parallel Swathing Option Plus for AgGPS 114 (PN 34623-40).1-10

1.5.2	Ag Field Pack (P/N 32294)1-10
1.6	Receiver Connections1-11
1.6.1	ASCII and TSIP Input1-12
1.6.2	RTCM, TSIP and NMEA Output1-12
1.6.3	1 PPS Output1-12

2 Installing the AgGPS 114 Receiver

2.1	Unpacking and Inspecting the Shipment2-2
2.1.1	Opening the Shipping Carton2-2
2.1.2	Reporting Shipping Problems2-3
2.2	Installation Guidelines2-4
2.2.1	Choosing a Location.2-4
2.2.2	Considering Environmental Conditions2-5
2.3	Mounting the Receiver2-6
2.3.1	Sources of Electrical Interference2-7
2.4	Routing and Connecting the AgGPS 114 Data/Power Cable.2-8
2.5	Connecting to External Devices2-9
2.5.1	Connecting the Optional Parallel Swathing Option Plus for AgGPS 114 and AgGPS 70 RDL (Cable PN 39350)	.2-10
2.5.2	Connecting the Optional CASE AFS Data/Power Cable (PN 32609)2-11
2.5.3	Connecting the Optional John Deere GreenStar Data Cable (PN 34189)2-12
2.5.4	Connecting the Optional Ag Leader Data/Power Cable (P/N 39903).2-14
2.5.5	Connecting the Optional RDS Yield Monitor Data/Power Cable (PN 35142)2-17
2.5.6	Connecting the AgGPS 114 Data/Power cable (40947) to the RDS Pro Series 80002-17
2.5.7	Connecting the Standard Data/Power Cable to a Laptop Computer (PN 40947).2-18

2.5.8	Connecting the Standard Data/Power Cable to a Windows CE Palmtop Computer (PN 40947 and PN 40572)2-19
2.5.9	Connecting the AgGPS 114 Data/Power Cable to a Windows CE Handheld Computer.2-20
2.5.10	Connecting the AgGPS 114 to a Micro-Trak Yield Monitor2-21

3 Getting Started

3.1	Using the Front Panel.3-1
3.1.1	Viewing Status Screens3-2
3.2	The Home Screen.3-4
3.2.1	Satellite Mode Home Screen3-5
3.3	Below Home Screen Configurables3-8
3.3.1	Contrast3-8
3.3.2	Units3-9
3.3.3	Configuration Lockout Screen.3-10
3.3.4	Language Screen.3-11

4 Configuring the AgGPS 114 Receiver

4.1	Configuring the AgGPS 114 Receiver4-1
4.1.1	Using the AgRemote Software to Change Configuration Settings4-2
4.2	Satellite DGPS Activation Configuration4-3
4.2.1	DGPS Source4-3
4.2.2	Easy Satellite DGPS Configuration4-5
4.2.3	Satellite Frequency4-6
4.2.4	Satellite Baud4-7
4.2.5	OmniSTAR Activation.4-7
4.3	Racal Solution4-8
4.4	Configuring Port Parameters4-9

4.4.1	Setting the Port Input /Output Parameters	4-10
4.4.2	NMEA 1 Settings	4-11
4.4.3	NMEA 2 Settings	4-12
4.4.4	NMEA 3 Settings	4-12
4.4.5	Message Rate	4-13

5 Troubleshooting

5.1	Increasing GPS Accuracy	5-1
5.2	Intermittent GPS Loss	5-3
5.3	Power Lines and Strong Magnetic Fields	5-3
5.4	Choosing an Mounting Location	5-4
5.5	Checking for Cable Failure.	5-4
5.6	Reducing Engine Noise.	5-4
5.7	Why Satellite DGPS Works in Some Places But Not Others	5-5
5.8	Verifying the Unit is Outputting NMEA Messages	5-5
5.9	Losing Configuration Settings When the Receiver is Powered Off	5-5
5.10	Restoring the Receiver to Factory Defaults	5-6
5.10	Troubleshooting Guides	5-7

A Specifications

B Receiver Defaults

C Cables and Connectors

C.1	AgGPS 114 Power/Data Cable (PN 40947)	C-2
C.2	AgGPS 114 PSO Plus Cable (PN 39350).	C-3
C.3	Ag Leader Interface Cable (PN 39903)	C-4
C.4	Case AFS Cable	C-5
C.5	John Deere GreenStar Data Cable	C-5
C.6	RDS Data Power Cable.	C-6

D NMEA-0183 Sentences

D.1	NMEA-0183 Sentence StructureD-2
D.1.1	Symbols and DelimitersD-3
D.1.2	Checksum ValuesD-4
D.1.3	Field FormatsD-5
D.1.4	Null FieldsD-5
D.1.5	Talker ID CodesD-5
D.1.6	Latitude and Longitude ValuesD-6
D.1.7	Time ValuesD-6
D.1.8	Other ValuesD-6
D.1.9	Reading NMEA String FormatD-6
D.2	NMEA Sentence SummaryD-7
D.3	ALM SentenceD-9
D.4	GBS SentenceD-10
D.5	GGA SentenceD-11
D.6	GLL SentenceD-12
D.7	GRS SentenceD-13
D.8	GSA SentenceD-14
D.9	GST Sentence.D-15
D.10	GSV SentenceD-16
D.11	MSS SentenceD-17
D.12	RMC SentenceD-18
D.13	VTG SentenceD-20
D.14	XTE SentenceD-21
D.15	ZDA SentenceD-22
D.16	PTNLAG001 Proprietary Sentence.D-23
D.17	PTNLEV Proprietary Sentence.D-24
D.18	PTNLID Proprietary SentenceD-25
D.19	PTNLDG Proprietary SentenceD-26
D.20	PTNL,GGK Sentence.D-28

D.21 PTNLSM Proprietary SentenceD-29

E Flash Loader 100

E.1 Connecting to the Flash Loader SoftwareE-2
E.2 Using Flash Loader 100E-3
E.3 Running Flash Loader 100E-4

F Activating Satellite DGPS Service

F.1 OmniSTAR ActivationF-7
F.2 Racal ActivationF-9

G Fast Rate Output

G.1 Setting Port A or B for Fast Rate OutputG-1
G.2 Configuring the AgGPS 114 Receiver for Fast Rate OutputG-2

H Connecting the AgGPS 114 Using AgRemote Software

H.1 Installing the AgRemote SoftwareH-1
H.2 Connecting the AgGPS 114 ReceiverH-2
H.3 Troubleshooting the ConnectionH-2

I AgGPS Menu System

Index

Reader Comment Form

List of Figures

Figure 1-1	AgGPS 114 Receiver	1-1
Figure 1-2	AgGPS 114 Bottom View	1-11
Figure 2-1	AgGPS 114 Standard Data/Power Cable Connections	2-8
Figure 2-2	Parallel Swathing Option Plus for AgGPS 114 and AgGPS 70 RDL	2-10
Figure 2-3	CASE AFS Power/Data Cable Connection	2-11
Figure 2-4	GreenStar Data Cable Connection	2-12
Figure 2-5	Ag Leader Data Cable Connection to YM2000	2-14
Figure 2-6	Ag Leader Data/Power Cable Connection to PF3000	2-15
Figure 2-7	Ag Leader Data/Power Cable Connection to PF3000 PRO	2-16
Figure 2-8	AgGPS 114 Data/Power Cable to RDS Pro Series 8000	2-17
Figure 2-9	AgGPS 114 Data/Power Cable to a Laptop Computer	2-18
Figure 2-10	AgGPS 114 Data/Power Cable and Null Modem to Windows CE Palmtop Computer	2-19
Figure 2-11	AgGPS 114 Receiver to Windows CE Handheld Computer	2-20
Figure 2-12	AgGPS 114 Receiver to Micro-Trak Yield Monitor	2-21
Figure 3-1	AgRemote Front Screen Simulator.	3-2
Figure 3-2	Home Screen Hierarchy	3-4
Figure 3-3	GPS Status	3-6
Figure 3-4	Satellite DGPS Status.	3-7
Figure 5-1	System Hardware and Power Check Guide	5-7
Figure 5-2	GPS Reception Troubleshooting Guide	5-9
Figure 5-3	GPS Reception Troubleshooting Guide - Using a Yield Monitor	5-11

List of Figures

Figure 5-4	OmniSTAR Troubleshooting Guide	5-14
Figure 5-5	Racal-LandStar Troubleshooting Guide.	5-16
Figure D-1	Sample ZDA Sentence Structure	D-2
Figure F-1	OmniSTAR Activation Guide.	F-7
Figure F-2	Racal-LandStar Activation Guide	F-9

List of Tables

Table 2-1	AgGPS 114 Receiver	2-2
Table 2-2	AgGPS 114 Components	2-2
Table 2-3	AgGPS 114 Receiver Enhancements	2-2
Table 2-4	AgGPS 114 Application Options	2-3
Table 2-5	Optional Components.	2-3
Table 3-1	Keypad Actions	3-2
Table 3-2	Position Types	3-6
Table 3-3	DGPS Signal-to-Noise Values	3-7
Table 3-4	Satellite Differential Mode Status Indicators.	3-7
Table 4-1	DGPS Source Settings	4-4
Table 4-2	Racal Station Settings.	4-8
Table 4-3	Port Input Parameter Settings.	4-10
Table A-1	AgGPS 114 Receiver	A-1
Table A-2	GPS Channels.	A-2
Table A-3	L-Band Satellite Differential Correction Receiver with Multiple Vendor Support	A-2
Table B-1	Receiver Defaults	B-1
Table C-1	Ag114 Power/Data Cable (PN 40947) Port A (9-Pin) & Port B (12-Pin) Connectors	C-2
Table C-2	AgGPS 114 PSO Plus Cable Pin-out (P/N 39350).	C-3
Table C-3	Ag Leader Yield Monitor Cable Pin-out (P/N 39903)	C-4
Table C-4	Case AFS Cable Pin-out (P/N 32609)	C-5
Table C-5	John Deere GreenStar Data Cable Pin-out (P/N 34189)	C-5
Table C-6	RDS Data Power Cable Pin-out (P/N 35142).	C-6

List of Tables

Table D-1	Sample ZDA Sentence Structure	D-3
Table D-2	Supported Talker ID Codes	D-5
Table D-3	Supported NMEA-0183 Sentences.	D-7
Table D-4	ALM Sentence Fields.	D-9
Table D-5	GBS Sentence Fields	D-10
Table D-6	GGA Sentence Fields	D-11
Table D-7	GLL Sentence Fields	D-12
Table D-8	GRS Sentence Fields	D-13
Table D-9	GSA Sentence Fields	D-14
Table D-10	GST Sentence Fields	D-15
Table D-11	GSV Sentence Fields	D-16
Table D-12	MSS Sentence Fields	D-17
Table D-13	RMC Sentence Fields.	D-18
Table D-14	VTG Sentence Fields	D-20
Table D-15	XTE Sentence Fields	D-21
Table D-16	ZDA Sentence Fields	D-22
Table D-17	PTNLAG001 Sentence Fields	D-23
Table D-18	PTNLEV Sentence Fields	D-24
Table D-19	PTNLID Sentence Fields	D-25
Table D-20	PTNLDG Sentence Fields	D-27
Table D-21	PTNL,GGK Sentence Fields	D-28
Table D-22	PTNL,SM Sentence Fields	D-29
Table E-1	Flash Loader 100 Options	E-3

About This Manual

Welcome to the *AgGPS 114 Operation Manual*. This manual describes how to install and configure the AgGPS™ 114 receiver. It includes step-by-step instructions for installing the AgGPS 114 receiver and guidelines for using the AgRemote software program for viewing and configuring receiver operating parameters. Also included are guidelines for interfacing the receiver to a PC, agricultural yield monitors, information about the selection of NMEA messages supported by the receiver, and connector pin-out diagrams for different data cable connections.

Scope and Audience

Even if you have used other Global Positioning System (GPS) products before, we recommend that you spend some time reading this manual to learn about the special features of this product. If you are not familiar with GPS, we suggest that you read the booklet *GPS, A Guide to the Next Utility*, available from Trimble.

The following sections provide a guide to this manual, as well as to other documentation that you may have received with this product.

Organization

This manual contains the following:

- Chapter 1, Overview, provides a brief overview of Differential GPS, and AgGPS 114 components.
- Chapter 2, Installing the AgGPS 114 Receiver, contains installation and interfacing instructions for the AgGPS 114 receiver.
- Chapter 3, Getting Started, gives instructions for using AgRemote's front panel display and keypad.
- Chapter 4, Configuring the AgGPS 114 Receiver, gives instructions for configuring AgGPS 114 operating parameters.
- Chapter 5, Troubleshooting, gives guidelines for solving potential problems.
- Appendix A, Specifications, identifies the physical characteristics and general specifications of the AgGPS 114 receiver.
- Appendix B, Receiver Defaults, contains the default settings for the AgGPS 114 receiver.
- Appendix C, Cables and Connectors, includes pin-out diagrams for the standard and optional cables.
- Appendix D, NMEA-0183 Sentences, describes the structure of NMEA messages generated by the AgGPS 114 receiver and the information included in them.
- Appendix E, Flash Loader 100, explains how to use the Flash Loader 100 software to update the receiver firmware.
- Appendix F, Activating Satellite DGPS Service, provides step-by-step instructions for activating a satellite DGPS service.
- Appendix G, Fast Rate Output, gives instructions for configuring the AgGPS 114 receiver for Fast Rate output.

- Appendix I, AgGPS Menu System, includes the AgGPS Menu System navigation map.

Other Information

This section lists sources that provide other useful information.

World Wide Web (WWW) Site

For an interactive look at Trimble Precision Agricultural Products, visit our site on the World Wide Web:

- <http://www.trimble.com/precise/agri/index.htm>

Technical Assistance

If you have a problem and cannot find the information you need in this product manual, **contact the local dealer** from which you purchased your AgGPS 114 DGPS receiver.

If you need further assistance, contact the Overland Park, Kansas office by phone, fax, or email. A support technician can help determine the cause of the problem and provide technical assistance.

Phone: +1-913-495-2700 (International & North America)
(8:00 am to 5:00 pm Central Standard Time)

Fax: +1-913-495-2750

Email: precision_ag@trimble.com

When you contact Overland Park, Kansas, provide the following information:

- The Trimble product name, any software or firmware version number(s), and if appropriate, the receiver serial number.
- Your specific question or problem.

Please detail background information, such as the configuration of your receiver, and the exact type, make, and configuration of your computer. Specify the software program on your computer you are using with your GPS receiver. If you have received error messages, please specify the exact wording.

If you need to send a data file with your inquiry, please compress the file using WINZIP software and name the file with the extension.ZIP. WINZIP software is available from:

<http://www.winzip.com>

To send the file, attach the file to your email message and send it to:

precision_ag@trimble.com

Reader Comment Form

Thank you for purchasing this product. We would appreciate feedback about the documentation. Use the reader comment form at the back of this manual or, if this is not available, send comments and suggestions to the address in the front. All comments and suggestions become the property of Trimble Navigation Limited.

Document Conventions



Italics identify software menus, menu commands, dialog boxes, and the dialog box fields.

SMALL CAPITALS identify DOS commands, directories, filenames, and filename extensions.





Courier represents messages printed on the screen.

Courier Bold represents information that you must type in a software screen or window.

Helvetica Bold identifies a software command button.

 or  +  identifies a hardware function key or key combination that you must press on a PC.

Screen Font is used to show information displayed on the AgGPS 114 LCD display.

, , , , and  are the buttons on the AgRemote software program screen.

Warnings, Cautions, Notes, and Tips

Warnings, cautions, notes, and tips draw attention to important information and indicate its nature and purpose.



Warning – Warnings alert you to situations that could cause personal injury or unrecoverable data loss.



Caution – Cautions alert you to situations that could cause hardware damage or software error.



Note – Notes give additional significant information about the subject to increase your knowledge, or guide your actions.



Tip – Tips indicate a shortcut or other time- or labor-saving hint that can help you make better use of the product.

1 Overview

The AgGPS 114 is a high-performance GPS reception and satellite DGPS capability receiver and antenna in a single, lightweight, durable, waterproof housing.

Additionally, the AgGPS 114 receiver (see Figure 1-1) contains The Choice™ technology, enabling OmniSTAR and Racal-LandStar real-time differential capabilities.

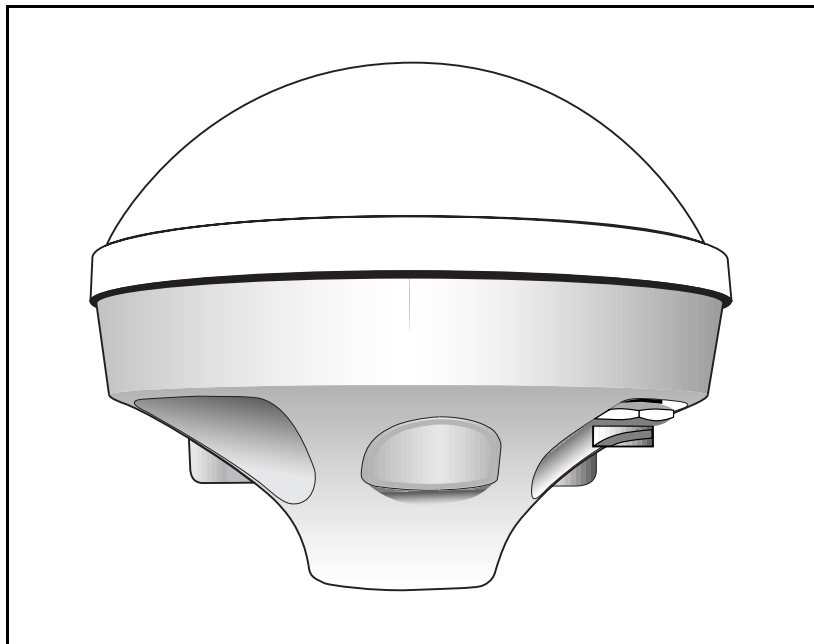

Figure 1-1 AgGPS 114 Receiver

As a part of a precision agriculture system, the AgGPS 114 receiver outputs submeter GPS position information to a variety of farming equipment, including yield monitors, parallel swathing guidance systems, variable rate planters, spray application and soil sampling controllers, and portable field computers.

The AgGPS 114 receiver outputs real-time submeter positions and 0.1 mile-per-hour (0.16 kph) velocity accuracy through NMEA-0183 and TSIP (Trimble Standard Interface Protocol) messages. A 1 PPS (pulse per second) strobe signal can also be used to synchronize time and log event marker input when using external instruments.

1.1 Differential GPS Positioning

The AgGPS 114 receivers use differential GPS (DGPS) to achieve submeter (<3.28 ft) accuracy. DGPS requires two or more receivers. One receiver, called the reference or base station, is located at a known point to determine the GPS measurement errors. An unlimited number of mobile AgGPS 114 receivers, sometimes called rovers, collect data at unknown locations within the transmission range of the reference station. The reference station broadcasts correction values, which are applied to the AgGPS 114 receiver position. Errors common at both the reference and rover receivers are corrected. For more information about DGPS and the different DGPS signals available, review the *Differential GPS Explained* introductory book available from Trimble.

1.1.1 Sources of GPS Error

The largest source of GPS position error is Selective Availability (S/A). S/A is induced by the U.S. government for the purpose of restricting full GPS accuracy to all except authorized users. The magnitude of S/A combined with other error sources results in autonomous (single receiver) horizontal accuracies of up to 100 meters (328 feet). If the U.S. government turns S/A off, autonomous GPS horizontal accuracy would be about 10 meters (32.8 feet).

Atmospheric conditions (especially in the ionosphere), multipath (GPS signals bouncing off objects before reaching the antenna), and receiver (electronic) noise are in large part responsible for the remaining 10 meters (32.8 feet) of error.

DGPS removes most of the errors caused by S/A and the atmosphere. The AgGPS 114 receiver uses the latest advancements in receiver design to minimize these errors. For more information about S/A, atmospheric effects, and other sources of error, review the *All About GPS* tutorials found on the Trimble web site (WWW.TRIMBLE.COM).

1.1.2 DGPS Accuracy

Accuracy of the AgGPS 114 receiver with differential correction is better than 1 meter RMS (3.2 feet) + 10 ppm times the distance between the reference station and the mobile receiver given the following conditions:

- Number of satellites used: > 5
- PDOP: < 4
- Signal to Noise Ratio: > 6
- Satellite Elevation Mask: > 7.5
- Low multipath environment
- RTCM-compatible corrections broadcast from a Trimble 4000RSi or equivalent

Number of visible satellites

Four or more satellites must be visible to calculate a three-dimensional position (latitude and longitude, altitude, and time). Three or more satellites must be visible to calculate a two-dimensional position (latitude and longitude, and time). One or more satellites must be visible to compute a zero-dimensional (time only) position. Three-dimensional positions are the most accurate. On the AgGPS 114 receiver you can set configurations to determine how many satellites are used to compute GPS positions.

Position Dilution of Precision (PDOP)

PDOP is a unitless measure indicating when the satellite geometry can provide the most accurate results. When satellites are spread around the sky, the PDOP value is low and the computed position is most accurate. When the satellites are grouped closely together, the PDOP is high and positions are less accurate. You can configure a PDOP Mask to control the point at which the AgGPS 114 receiver stops outputting position reports. For submeter accuracy, the PDOP must be 4 or less.

In some agricultural applications, a PDOP Mask of 12 or more can be used to prevent loss of data. However, accuracy can suffer as PDOP rises. There is a trade-off between optimal GPS accuracy and continuous operation.

Signal-to-Noise Ratio

Signal-to-Noise Ratio (SNR) is a measure of the satellite signal strength. Accuracy improves as the signal strength increases. More signal strength with less noise interference equals better accuracy. To compute positions with strong signals, the SNR mask should be set to the default, 6 or more.

Elevation Mask

When a satellite is low on the horizon, the GPS signals must travel a great distance through the atmosphere, delaying reception by the AgGPS 114 receiver. You can minimize noisy data by adjusting (tuning) the Elevation Mask. Satellites below the mask are excluded from the position computation. The recommended setting for highest accuracy is 8°. There is a trade-off between accuracy and continuous operation; lowering the mask ensures continuous operation. Raising the elevation mask ensures a better position fix; less satellites available may cause loss of a required 3-dimensional fix when working in area with an obstructed view of the sky.

Multipath

GPS signals are sometimes reflected off nearby objects, particularly metallic objects, creating false or erroneous results. This phenomenon is known as multipath. Severe multipath can induce errors of many meters, while mild multipath may cause small, undetectable errors. Optimal accuracy is obtained by collecting data in an environment that is devoid of large reflective surfaces, like buildings and trees. The AgGPS 114 receiver's Everest™ multipath reduction option helps reduce the effects of multipath.

1.2 Measuring GPS Accuracy

To measure GPS accuracy you must have some knowledge of coordinates and datums. When comparing geographic data obtained from different sources, the data must be referenced to the same datum and coordinate system. Different datums and coordinate systems provide different coordinate values for any geographic location.

In North America, for example, two different datums, NAD 27 and NAD 83, are commonly used. A particular place on the surface of the earth has different latitude and longitude coordinates in each datum. The AgGPS 114 receivers provide coordinates in the WGS-84 datum. Existing background maps for the NAD 27 datum do not register with GPS data based on the NAD 83 datum.



Note – The North American Datum 1983 (NAD 83) is, for all practical purposes, equivalent to WGS-84 (World Geodetic Survey 1984). GPS data is referenced to the WGS-84 datum.

1.2.1 Receiving Satellite DGPS

Satellite differential GPS signals are sent from a ground station through a satellite transponder to users within view of the satellite. The corrections are sent in a format that allows the construction of a local differential correction applicable to the entire coverage region.

The AgGPS 114 receiver contains both OmniSTAR and Racal-LandStar satellite differential technology. To enable satellite differential capabilities, contact either supplier. Depending on which supplier is involved, the receiver can be activated by an over-the-air signal or an encrypted activation message entered by the AgRemote software program.

Satellite differential signals provide valid corrections over a large area, but are decoded to provide an accurate correction applicable to any location within the satellite view area. This is accomplished by special software algorithms for generating wide area differential corrections. These algorithms, called Virtual Reference Station (VRS)

and Virtual Base Station (VBS), depending on the vendor, compute differential corrections that a base station would generate if it were at the receiver's location. This correction is constantly updated, so as the receiver moves around, the correction remains at full accuracy.

Satellite differential signals are line-of-sight and can be blocked by a mountain, hill, or tree canopy. Wet canopy, from a heavy rain, reduces the signals even more. The same local environmental factors, like radar and microwave transmitters, that affect the GPS signals can interfere with the satellite signals. Power lines usually have no effect.

For specific information about the providers, visit WWW.OMNISTAR.COM or WWW.RACAL-LANDSTAR.COM on the World Wide Web.

1.3 Standard Features

The standard AgGPS 114 system provides the following:

- 12 GPS (C/A-code) tracking channels, carrier-phase filtering
- Submeter differential accuracy (RMS): assumes at least 5 satellites and PDOP less than 4
- Combined GPS/DGPS receiver & antenna
- Magnetic antenna mount
- Data/Power cable
- AgRemote software program that simulates the AgGPS 124/132 LCD display interface with four-button keypad to configure and view system properties
- Two RS-232 serial ports and 1 J1939 CAN-ready port (CAN 2.0B):
 - NMEA-0183 output: ALM, GGA, GLL, GRS, GST, GSA, GSV, MSS, RMC, VTG, ZDA, XTE (The default NMEA messages are GGA, GSA, VTG and RMC)
 - RTCM SC-104 output
 - TSIP input and output
 - Outputs 1 PPS (pulse per second) strobe signal on either serial port, allowing an external instrument to synchronize its internal time with the AgGPS 114 clock oscillator.
- WAAS/EGNOS Differential Correction Upgrade available
- AgGPS 170 Field Computer compatible
- AgGPS 70 Remote Data Logger compatible

1.4 Receiver Enhancements

AgGPS 114 systems contain several point-of-sale purchase options designed to maximize receiver performance. Depending on the system you ordered, the following options may or may not be included.

1.4.1 Fast Rate (P/N 33176-10)

The Fast Rate option enables the AgGPS 114 receiver to output position data up to 10 times per second. Fast Rate output is important in parallel swathing and variable rate applications. (5 Hz Fast Rate option is activated when the Parallel Swathing Option is connected.)

1.4.2 Everest Technology (P/N 33176-40)

The Everest™ multipath reduction option improves DGPS receiver accuracy by filtering reflected GPS signals before they are processed by the DGPS receiver. Everest technology provides maximum accuracy near trees, buildings, and reflective surfaces. (The Everest multipath reduction option is activated when the Parallel Swathing Option is connected.)

1.5 Application Options

The AgGPS 114 system contains several purchase options that increase the number of applications for which the AgGPS 114 receivers can be used.

1.5.1 Parallel Swathing Option Plus for AgGPS 114 (PN 34623-40)

The AgGPS Parallel Swathing option enhances the AgGPS 114 receiver with an easy-to-use, plug-and-play lightbar. The lightbar indicates off-track error, which the operator uses to steer back on-line.

The AgGPS Parallel Swathing Option helps reduce farm expenses by minimizing redundant applications and skipped areas. Efficient field coverage enables maximum ground coverage in the shortest possible time. Swath coverage maps show the actual field area covered, quality of application & document the date of application.

Independent data ports enable the AgGPS 114 receiver to simultaneously control the lightbar and output data to a variable rate controller or other device.

1.5.2 Ag Field Pack (P/N 32294)

The Ag Field Pack includes the backpack, antenna poles, batteries, and cables to keep hands free when operating the AgGPS 114 receiver on foot. The Field Pack is available as either a rigid frame or lumbar pack; ideal for crop scouting and field mapping applications.

1.6 Receiver Connections

Figure 1-2 shows the bottom of the AgGPS 114 receiver and its connection port.

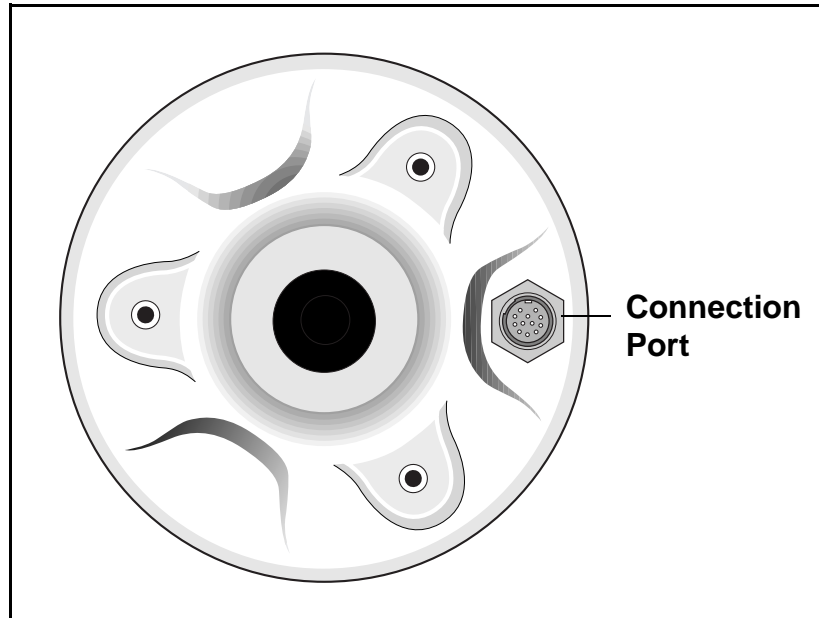

Figure 1-2 AgGPS 114 Bottom View

The connection port can accept power. The AgGPS 114 standard power/data cable (P/N 40947) supplies power and features a data connector for interfacing to an external device. For more information, see *Connecting to External Devices*, page 2-9.

1.6.1 ASCII and TSIP Input

The connection port can be used to input ASCII, TSIP and CAN data from an external device. ASCII data can be received from an external sensor, converted into a NMEA message, and exported to another device. TSIP command packets are used to set and monitor GPS and Satellite DGPS parameters using the included AgRemote software program.

1.6.2 RTCM, TSIP and NMEA Output

The connection port is used to output RTCM, TSIP, NMEA 0183 or CAN messages to an interface device. RTCM is output when operating in base station mode. TSIP is output when communicating with the included AgRemote software. NMEA is output when exporting GPS position information to an external device, such as a yield monitor or mapping software program. CAN is used when communicating over a CAN bus system to other connected external devices.

1.6.3 1 PPS Output

The connection port can output a 1 PPS (pulse per second) strobe signal to synchronize the external instruments to the receiver's internal clock.

2 Installing the AgGPS 114 Receiver

This chapter shows you how to:

- Unpack and inspect the shipment
- Install the following:
 - AgGPS 114 receiver
 - Connect to the AgGPS Lightbar, AgGPS 70 RDL, field computers and yield monitors

We recommend that you read this chapter before attempting to install your AgGPS 114 receiver.

2.1 Unpacking and Inspecting the Shipment

Inspect the shipping cartons for any signs of damage or mishandling before unpacking the receiver.

Report any damage to the shipping carrier immediately.

2.1.1 Opening the Shipping Carton

The shipment could include one or more cartons, depending on the number of optional accessories ordered. Open the shipping cartons and make sure that all of the components indicated in Tables 2-1 and 2-2 are included.

Table 2-1 AgGPS 114 Receiver

Qty	P/N	Description
1	38198-00	AgGPS 114 Combination Receiver and Antenna

Table 2-2 AgGPS 114 Components

Qty	P/N	Description
1	12920-00	Magnetic Mount for Antenna
1	40947	AgGPS 114 Data/Power Cable
1	38201-00	AgGPS 114 Operation Manual
1	41561	AgGPS Menu System Reference Manual

As shown in Table 2-3, the bill of lading could list one or more of the following factory installed enhancements.

Table 2-3 AgGPS 114 Receiver Enhancements

Qty	P/N	Description
1	33176-10	Fast Rate capability
1	33176-40	Everest Multipath Reduction Technology

As shown in Table 2-4, the bill of lading could list one or more of the following options.

Table 2-4 AgGPS 114 Application Options

Qty	P/N	Description
1	32294-00	Ag Field Pack 120 volts
1	32294-10	Ag Field Pack 240 volts
1	34623-20	Parallel Swathing Option Plus for AgGPS 114 and AgGPS 70 RDL
1	34623-40	AgGPS 21 PSO Plus for AgGPS 114
1	39600-00	AgGPS 70 Remote Data Logger

The bill of lading could include one or more of the items listed in Table 2-5 if optional components or accessories are ordered.

Table 2-5 Optional Components

Qty	P/N	Description
1	39903	Ag Leader Yield Monitor Data/Power Cable
1	30700	3.6-meter (12-foot) Extension Data Cable DE9-M to DE9-F
1	32609	CASE AFS Data/Power Cable
1	34189	John Deere GreenStar Data Cable
1	35142	RDS Yield Monitor Data/Power Cable
1	40572	Null Modem adapter

2.1.2 Reporting Shipping Problems

Report any problems discovered after you unpack the shipping cartons to both Trimble Precision Agricultural Systems and the shipping carrier.

2.2 Installation Guidelines

AgGPS 114 receivers are designed to be mounted on a level, flat surface with the antenna mounted upright. The round magnetic base should be placed on a flat metal surface. The bottom of the receiver has 3 threaded metal insert holes for mounting to a flat surface with screws.

2.2.1 Choosing a Location

The AgGPS 114 receiver can be installed in any convenient location within cable reach of interconnected external devices. The location you choose should:

- be at the highest point of the vehicle with no metal surfaces blocking view of the sky
- be within 3.6 meters (12 feet) of the external instrument port (the optional 3.6-meter (12-foot) extension cable can be used to extend the cable connection distance between the receiver and external devices).
- allow enough clearance between the top of the machine cab and machine shed or storage shed doors for mounting the receiver.

2.2.2 Considering Environmental Conditions

Although the AgGPS 114 receiver is located within a waterproof housing, it should be installed in a dry location. Avoid exposure to extreme environmental conditions, including:

- water
- excessive heat (> 65°C or 149°F)
- excessive cold (< -20°C or -4°F)
- high vibration
- corrosive fluids and gases
- Avoiding these conditions improves the receiver's performance and long-term product reliability.

2.3 Mounting the Receiver

To mount the receiver, use the following guidelines when selecting a location:

- Place the receiver on a flat surface along the center line of the vehicle (or centerline of machine applicator boom).
- Choose an area with a clear view to the sky above metal surfaces. The top of a mast or pole is recommended.
- Do not mount the antenna close to stays, electrical cables, metal masts, CB radio antennas, Cell phone antennas, air-conditioner units (machine cab blower fan) or machine accessory lights.
- Do not mount the antenna near transmitting antennas, radar arrays, or satellite communication equipment.
- Avoid areas with high vibration, excessive heat, electrical interference, and strong magnetic fields.



Caution – A metal combine grain tank extension may block low elevation satellites.

2.3.1 Sources of Electrical Interference

Several sources of electrical and magnetic noise are:

- gasoline engines (spark plugs)
- PC monitor screens
- alternators, generators or magnetos
- electric motors (blower fans)
- equipment with DC-to-AC converters
- switching power supplies
- radio speakers
- Hydrostatic Transmissions
- High-voltage power lines
- CB radio antennas
- Cellular phone antennas
- Machine accessory lights

2.4 Routing and Connecting the AgGPS 114 Data/Power Cable

A 5-meter (16.5-foot) data/power cable is included with your AgGPS 114 receiver (see Figure 2-1). One end of the cable features a 90-degree connector. The opposite end features a 9-pin connector (Port A) and a straight round 12-pin connector (Port B). Connect the 90-degree connector to bottom the receiver, then route the cable to the external device.

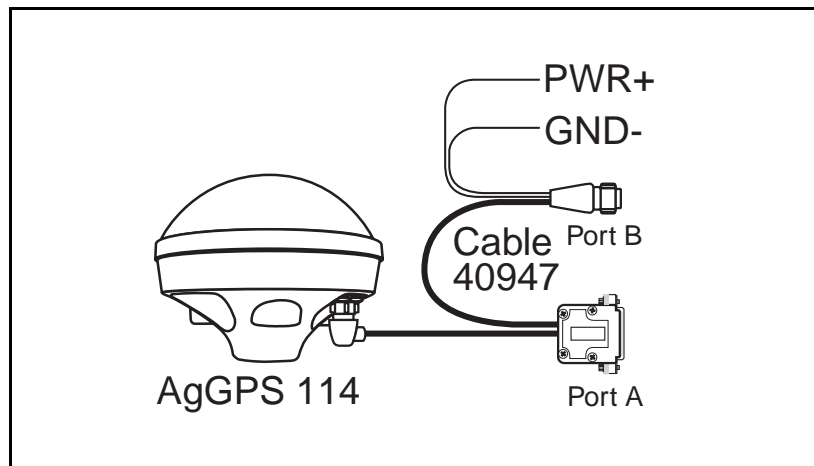

Figure 2-1 AgGPS 114 Standard Data/Power Cable Connections

When routing the data cable, avoid the following hazards:

- sharp ends or kinks in the cable
- hot surfaces (exhaust manifolds or stacks)
- rotating or moving machinery parts
- sharp or abrasive surfaces
- door and window jams
- corrosive fluids or gases

After routing the cable, connect it to the AgGPS 114 receiver. Use tie-wraps to secure the cable at several points along the route. One tie-wrap is required to secure the cable near the base of the receiver. This provides strain relief for the data cable connection.

When the cable is secured, coil any slack. Secure the coil with a tie-wrap and tuck it in a safe place.

2.5 Connecting to External Devices

After installing the receiver, connect and route the AgGPS 114 Data/Power cable. The receiver can be powered by a vehicle or a customer supplied 10–32 VDC power source.

The following sections contain installation instructions for different power/data cables. Depending on the cable(s) you own, complete the appropriate installation.

2.5.1 Connecting the Optional Parallel Swathing Option Plus for AgGPS 114 and AgGPS 70 RDL (Cable PN 39350)

The AgGPS 114 Parallel Swathing Option cable connects the AgGPS 114 receiver to the AgGPS Lightbar and AgGPS 70 Remote Data Logger (see Figure 2-2).

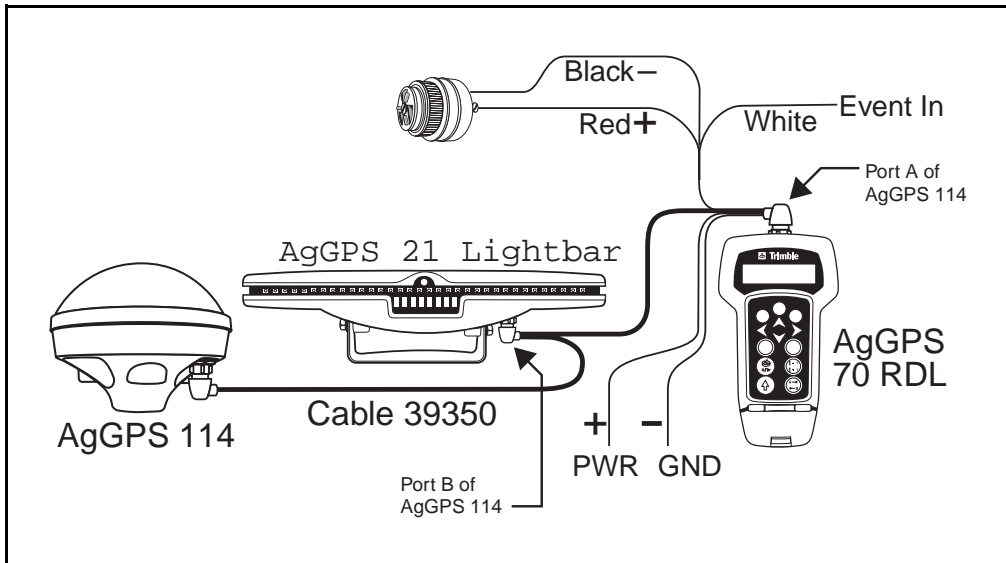

Figure 2-2 Parallel Swathing Option Plus for AgGPS 114 and AgGPS 70 RDL



Note – The red power lead must be connected to the +12 volts DC and the black power lead to Ground.

2.5.2 Connecting the Optional CASE AFS Data/Power Cable (PN 32609)

The 1-meter (3-foot) CASE AFS Data/Power Cable connects the AgGPS 114 receiver to a CASE AFS installation.

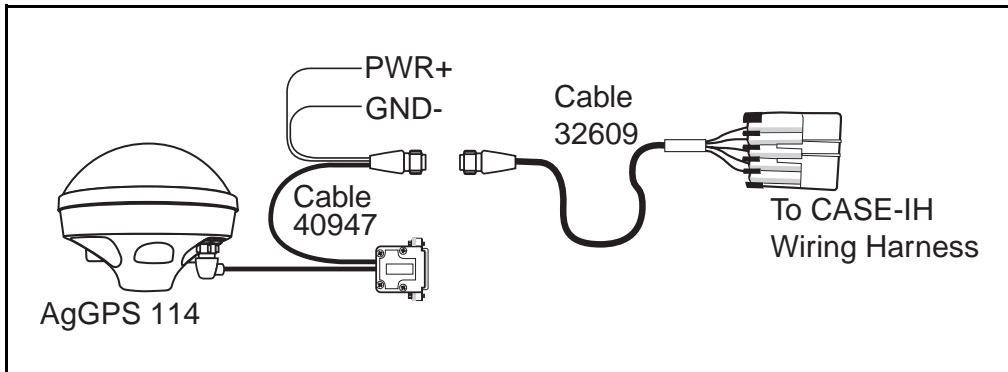

Figure 2-3 CASE AFS Power/Data Cable Connection

To connect the AgGPS 114 receiver to a CASE AFS installation:

1. Connect the flat grey 5-pin connector to the CASE AFS wiring harness.



Warning – The 40947 cable's red power lead and black power leads are not connected to machine power. The CASE AFS wiring harness supplies 12 VDC power to receiver.

2.5.3 Connecting the Optional John Deere GreenStar Data Cable (PN 34189)

The 1-meter (3-foot) John Deere GreenStar Data Cable connects the AgGPS 114 receiver to the John Deere GreenStar system (see Figure 2-4).

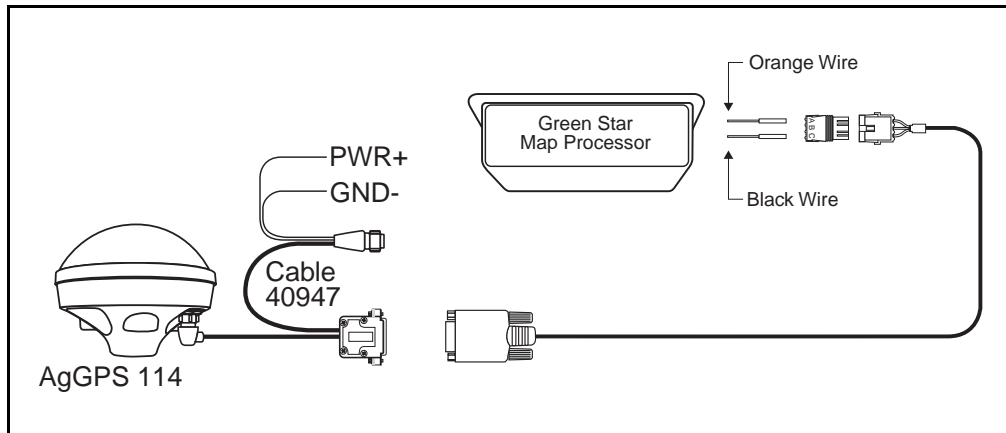

Figure 2-4 GreenStar Data Cable Connection

Before installing the AgGPS 114 receiver, you *must* determine if there is a GPS receiver currently attached to the GreenStar System.

- If there is *not* a GPS receiver attached to the GreenStar system, proceed with Step 1.
- If there is a GPS receiver attached to the GreenStar system, disconnect it from the wiring harness. This is required to activate the GreenStar RS-232 port. The harness can be disconnected from the GreenStar receiver at the antenna base located above the grain tank. When disconnected, proceed with Step 1.

To connect the AgGPS 114 receiver to the John Deere GreenStar system:

1. Inside the cab behind the seat, locate the wiring harness that connects to the GreenStar mapping processor. From this wiring harness, gently pull the three short wires from the black casing. (They are approximately 10 inches long; orange, black and blue; and sealed with shrink wrap). Do not use the blue cable.
2. Connect the orange wire, labeled 967, to the Metripack connector pin. Insert the pin into the Metripack connector slot A (PN 12015793).
3. Connect the black wire, labeled 20E, to the Metripack connector pin. Insert the pin into the Metripack connector slot C (PN 12015793).
4. Connect the AgGPS-GreenStar cable (P/N 34189) to the Metripack connector (PN 12015793).
5. Connect the data/power cable (PN 40947) to the AgGPS-GreenStar cable (PN 34189) 9-pin serial connector.
6. Attach the data power cable (PN 40947) to the connection port on the bottom of AgGPS 114 receiver.
7. Attach the power leads of the data/power cable (PN 40947) to switched DC power. Connect the red wire to positive and the black wire to negative (ground).

2.5.4 Connecting the Optional Ag Leader Data/Power Cable (P/N 39903)

The 3.6-meter (12-foot) Ag Leader Yield Monitor Cable connects AgGPS 114 receivers to both the Ag Leader Yield Monitor 2000 and PS3000 and PF3000 PRO (see Figures 2-5, 2-6, and 2-7).

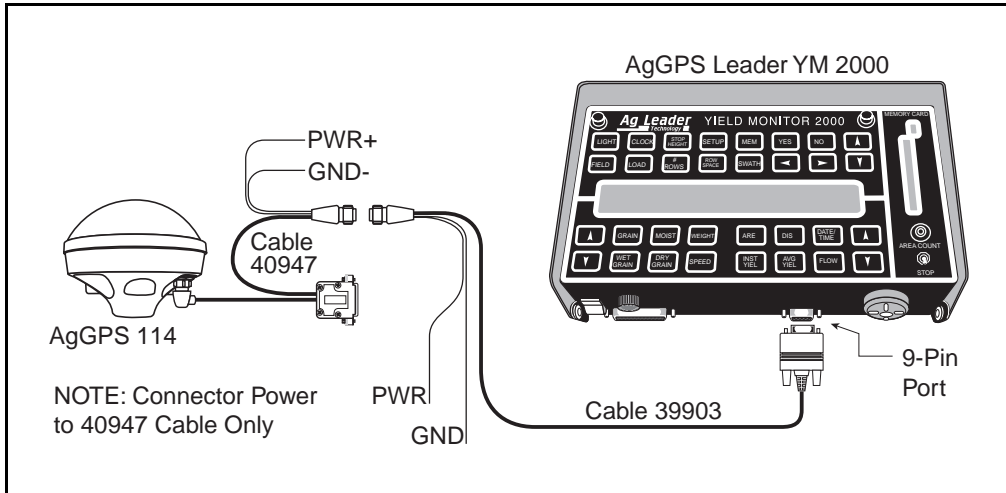

Figure 2-5 Ag Leader Data Cable Connection to YM2000



Note – The 40947 cable's red power lead must be connected to the +12 volts DC and the black power lead to Ground. The 39903 cable's red and black power leads are not connected to machine power.



Note – Install the optional 3.6-meter (12-foot) Extension Cable (PN 30700) to extend the Ag Leader Yield Monitor Cable to 7.2 meters (24 feet).

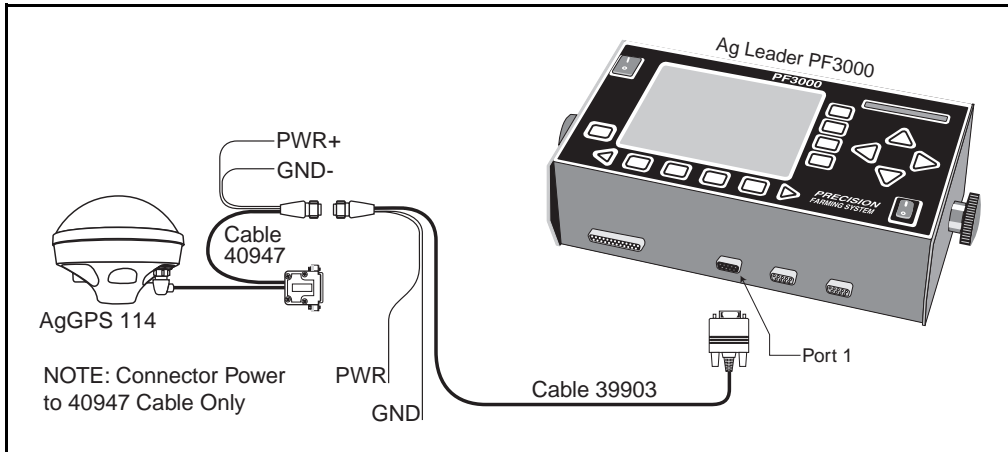

Figure 2-6 Ag Leader Data/Power Cable Connection to PF3000



Note – The 40947 cable's red power lead must be connected to the +12 volts DC and the black power lead to Ground. The 39903 cable's red and black power leads are not connected to machine power.



Note – Install the optional 3.6-meter (12-foot) Extension Cable (PN 30700) to extend the Ag Leader Yield Monitor Cable to 7.2 meters (24 feet).

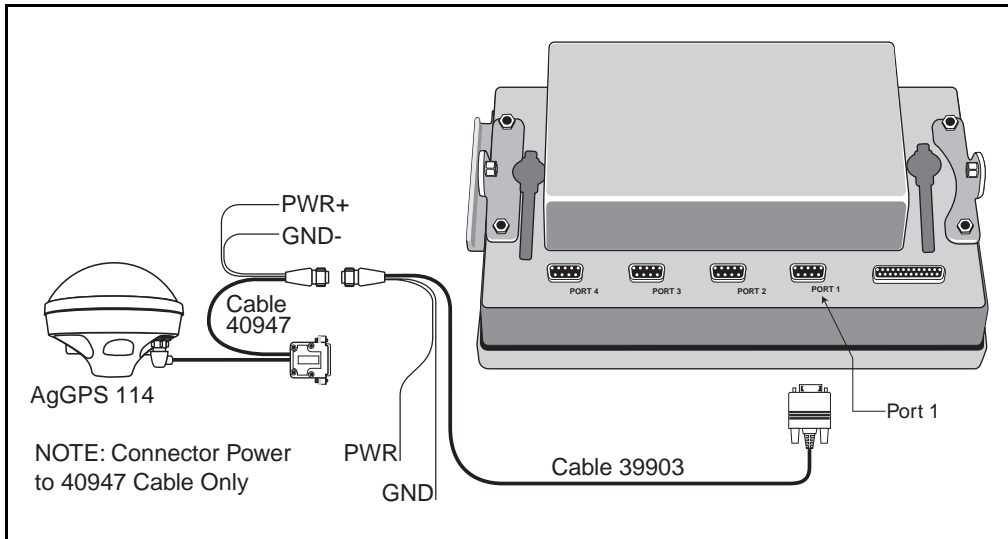

Figure 2-7 Ag Leader Data/Power Cable Connection to PF3000 PRO



Note – The 40947 cable's red power lead must be connected to the +12 volts DC and the black power lead to Ground. The 39903 cable's red and black power leads are not connected to machine power.



Tip – Install the optional 3.6-meter (12-foot) Extension Cable (PN 30700) to extend the Ag Leader Yield Monitor Cable to 7.2 meters (24 feet).

2.5.5 Connecting the Optional RDS Yield Monitor Data/Power Cable (PN 35142)

The 3.6 meter (12 foot) RDS Yield Monitor Data/Power cable connects an AgGPS 114 receiver to an RDS Ceres Yield Monitor.

To connect the optional RDS cable:

1. Connect the 12-pin CONXALL connector to the bottom of the AgGPS 114 receiver.
2. Attach the 9-pin RS 232 Connector to the RDS Ceres Yield Monitor.

2.5.6 Connecting the AgGPS 114 Data/Power cable (40947) to the RDS Pro Series 8000

Figure 2-8 shows the Data/Power cable (PN 40947) connection to the RDS Pro Series 8000.

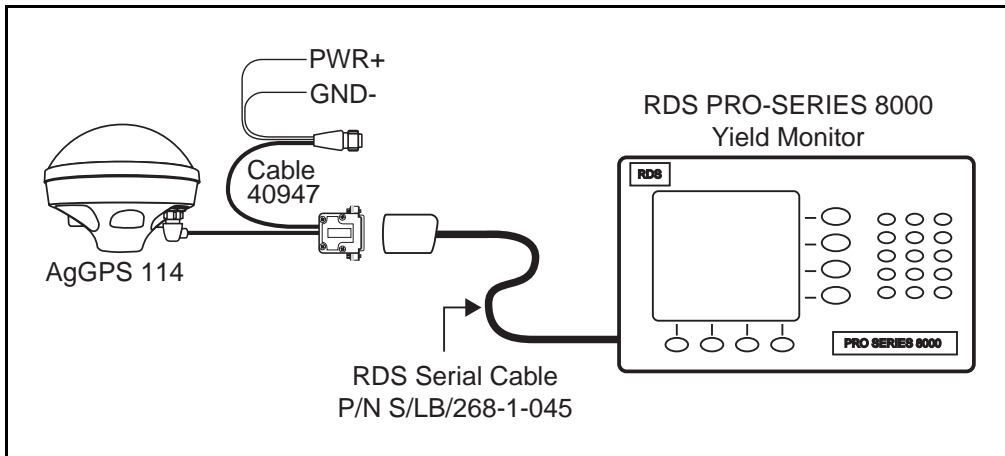

Figure 2-8 AgGPS 114 Data/Power Cable to RDS Pro Series 8000

2.5.7 Connecting the Standard Data/Power Cable to a Laptop Computer (PN 40947)

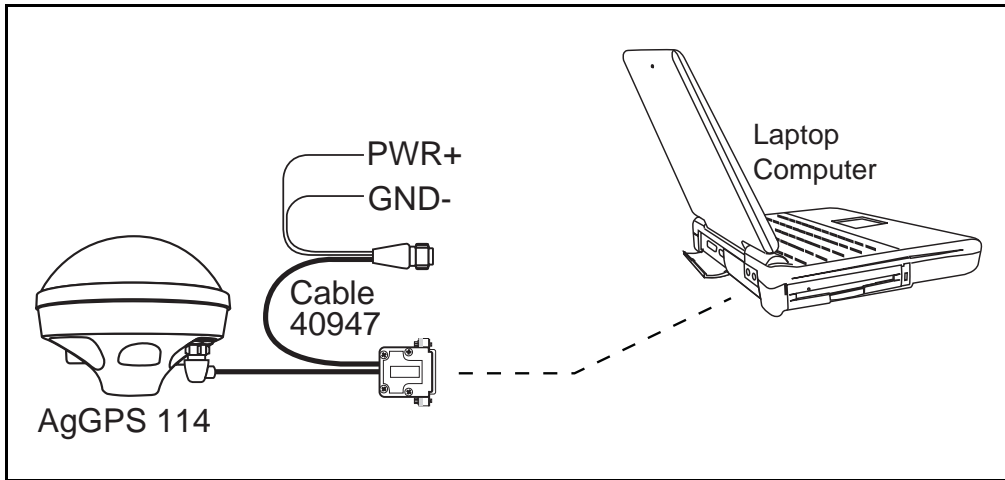

Figure 2-9 AgGPS 114 Data/Power Cable to a Laptop Computer

2.5.8 Connecting the Standard Data/Power Cable to a Windows CE Palmtop Computer (PN 40947 and PN 40572)

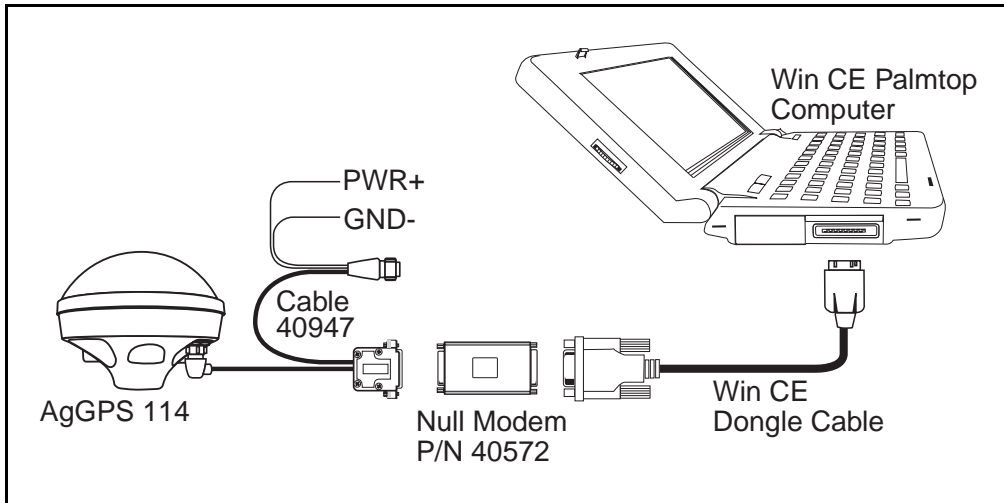

Figure 2-10 AgGPS 114 Data/Power Cable and Null Modem to Windows CE Palmtop Computer



Note – Attach the Null Modem adapter 9-pin RS 232 connector to the Windows CE computer (9-pin female connector).

2.5.9 Connecting the AgGPS 114 Data/Power Cable to a Windows CE Handheld Computer

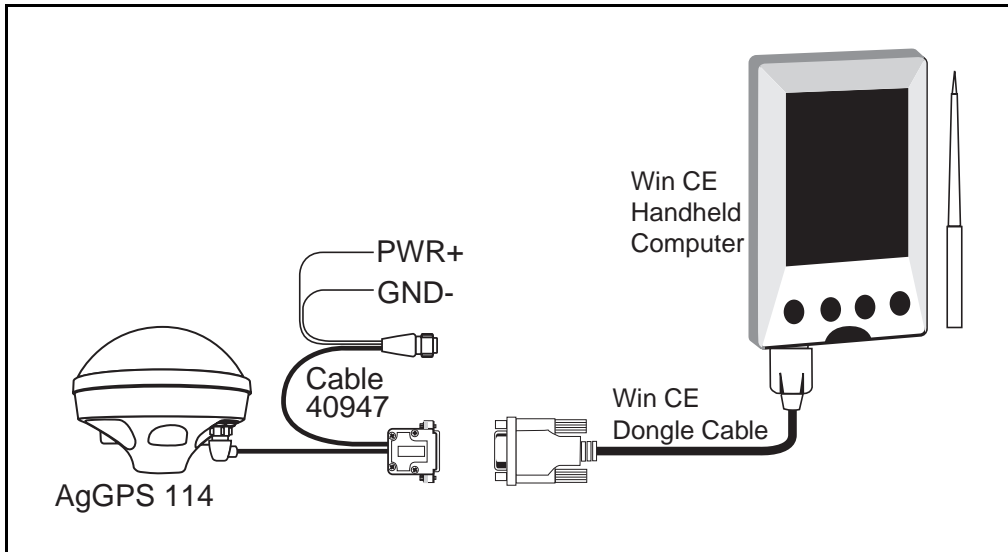

Figure 2-11 AgGPS 114 Receiver to Windows CE Handheld Computer

2.5.10 Connecting the AgGPS 114 to a Micro-Trak Yield Monitor

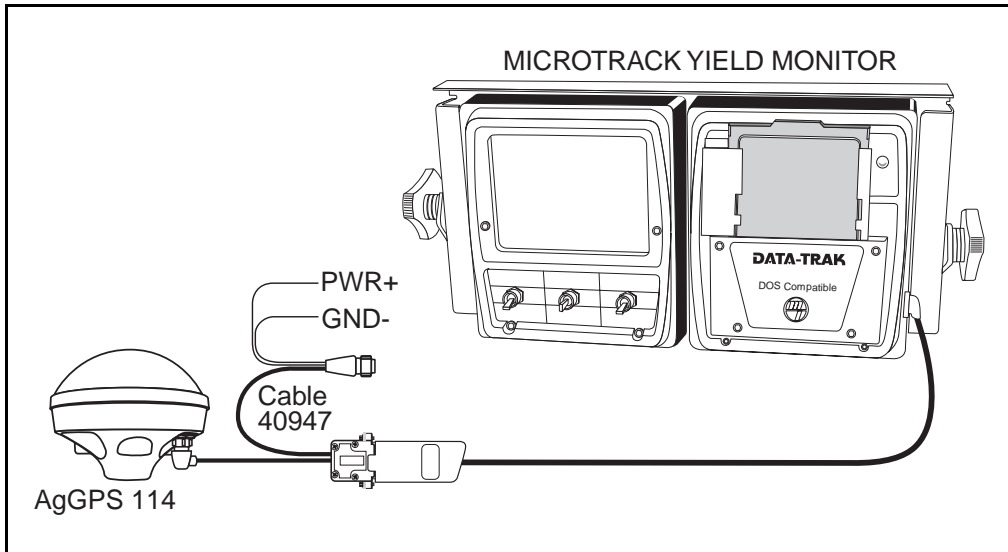

Figure 2-12 AgGPS 114 Receiver to Micro-Trak Yield Monitor



3 Getting Started

This chapter shows you how to use the AgRemote software's:

- Front screen simulator
- *Home* screen

We recommend that you read through this chapter to learn basic menu operations before attempting to use your AgGPS 114 receiver.

3.1 Using the Front Panel

After launching AgRemote from Microsoft Windows 95/98/NT4/2000 and powering on the receiver, the AgRemote software displays the *Home* screen. From the *Home* screen, click  or  to access other AgGPS menu system screens.

Two fold-out navigation maps are included in Appendix I, AgGPS Menu System. Fold open the navigation maps and use them for reference while navigating through the AgGPS menu system.

The remainder of Chapters 3 gives basic instructions for using the menu system, and Chapter 4 shows you how to configure the AgGPS 114 receiver for operation. Detailed information about the entire AgGPS menu system is included in the *AgGPS Menu System Reference*, also included with your AgGPS 114 receiver. Use this manual as a reference guide for learning details about individual AgGPS menu system screens.

3.1.1 Viewing Status Screens

Figure 3-1 shows the front screen simulator and the five keys used to navigate through the AgGPS menu system.

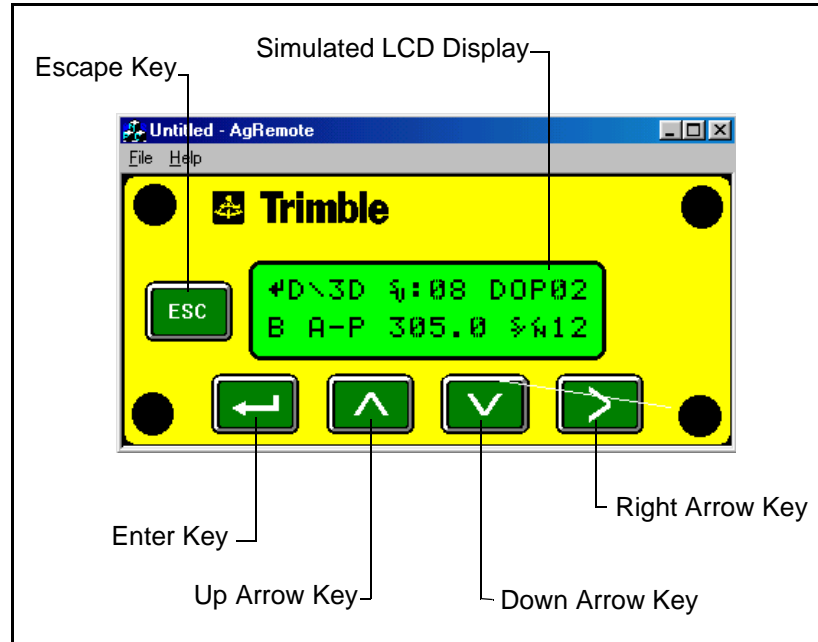

Figure 3-1 AgRemote Front Screen Simulator

Table 3-1 describes the actions performed by the AgRemote keys.

Table 3-1 Keypad Actions





Key	Description
	Performs several actions: <ul style="list-style-type: none"> Click  to cycle through the options displayed on a screen. When options are available, the  symbol appears in the upper right-hand corner of the screen.
	Click to cycles through the available screens.

Table 3-1 Keypad Actions (Continued)

Key	Description
▼	Click to cycles through the available screens.
➤	Click to moves through the main menu screens.
Esc	Performs several actions: <ul style="list-style-type: none"><li data-bbox="567 454 1183 519">• Moves back one level in screen hierarchy. Ultimately, it returns you to the <i>Home</i> screen.<li data-bbox="567 531 1183 630">• When in a configuration screen, it returns you to the main menu <i>Configuration</i> screen. Click again to return to the <i>Home</i> screen.

3.2 The Home Screen

The *Home* screen is just the first option in the main menu. The top line of the *Home* screen displays important GPS status indicators. The bottom line displays important DGPS indicators.

Figure 3-2 shows the *Home* screen and following screens.

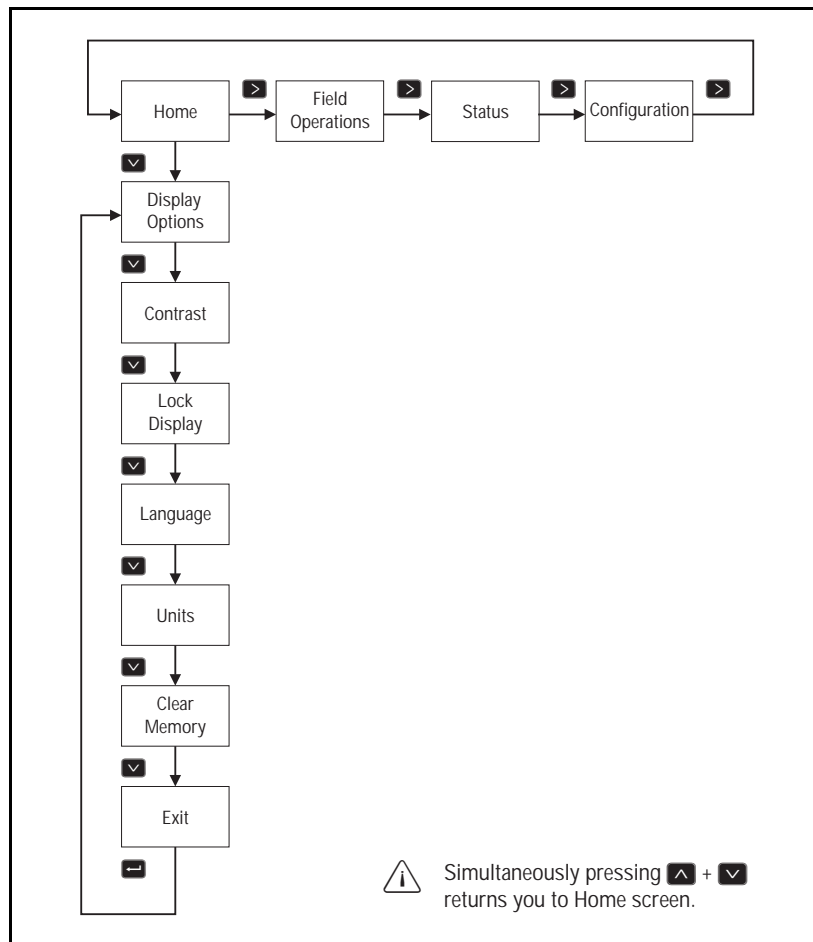

Figure 3-2 Home Screen Hierarchy

3.2.1 Satellite Mode Home Screen



Note – Reference to Satellite DGPS applies only to the AgGPS 114 132.

When satellite DGPS information appears in the *Home* screen, the AgGPS 114 receiver operates in Satellite Differential mode.

The following is a sample *Home* screen with Satellite DGPS:

```
G/3D  007 DOP03
S 1556.225 015
```

Figure 3-3 explains the GPS status indicators.

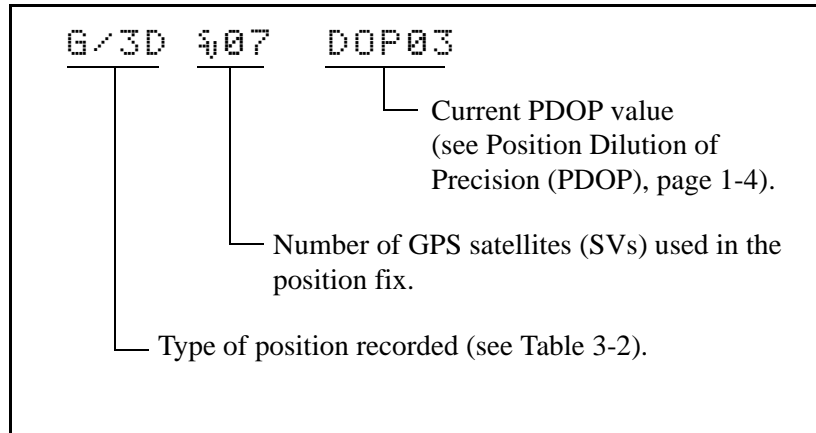

Figure 3-3 GPS Status

Table 3-2 Position Types

Display	Description
SRCH	Searching for satellites.
TRCK	Tracking satellites.
G/2D	Outputting 2-dimensional autonomous positions.
G/3D	Outputting 3-dimensional autonomous positions.
D/2D	Outputting 2-dimensional differential positions.
D/3D	Outputting 3-dimensional differential positions.



Note – The / symbol spins when the receiver is operating properly. When the / symbol is still, an error has occurred.

Figure 3-4 explains the satellite DGPS status indicators.

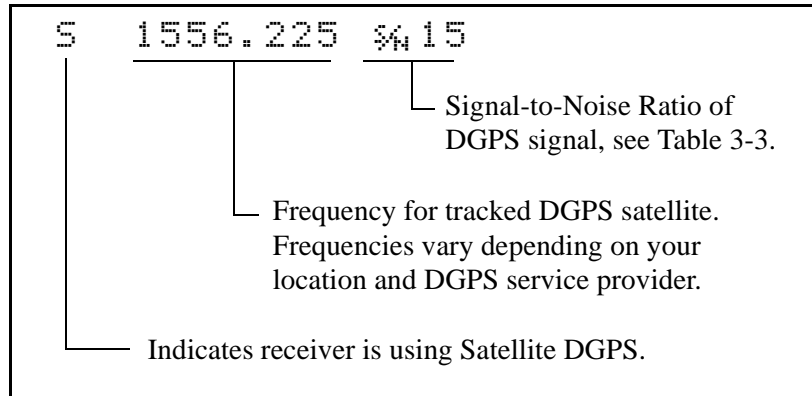

Figure 3-4 Satellite DGPS Status

Table 3-3 explains signal-to-noise ratio values.

Table 3-3 DGPS Signal-to-Noise Values

Value	Description
Below 4	Unusable
4–8	Fair
>8	Excellent

Table 3-4 shows the possible satellite differential mode indicators.

Table 3-4 Satellite Differential Mode Status Indicators

Indicator	Description
S #####.### S/N ##	Operating in Satellite Differential mode.
S SRCH ###.##	Searching for Satellite Differential signal.
S TRCK #####.##	Tracking satellite without acquiring signal lock.

3.3 Below Home Screen Configurables

The *Contrast*, *Units*, *Configuration Lockout* and *Language* settings are found under the *Home* screen. To display these screens:

1. Display the *Home* screen.
2. Press  to view the *Display Options* screen.



```
Display Options
Press v to Enter
```

3. Press .



3.3.1 Contrast

As lighting conditions change, the LCD display could become difficult to read. To decrease the contrast, enter a low number. Higher numbers increase screen contrast.



```
CON: Contrast
16
```

To change the contrast:



1. Press .
2. Press  to lighten the contrast.
3. Press  to darken the contrast.

3.3.2 Units

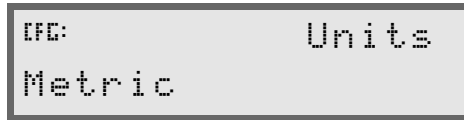
The *Units* screen enables the receiver to display either U.S. or Metric units. This setting does not affect data output.



To change the units:





1. Press .
2. Press  to select the appropriate units.
3. Press  to save.

3.3.3 Configuration Lockout Screen

The *Configuration Lockout* screen provides protection against tampering. To make the configuration screens invisible, input the last five digits of the receiver serial number. To view the configuration screens again, input the five-digit number a second time.



To enter the password:

1. Press  to enter the Lock Display screen.
2. Press  or  to input the values.
3. Press  to input the next number.
4. Continue until complete.
5. Press  to accept.

When complete, Valid Password appears. The configuration screens are not visible. Repeat the procedure above to unlock the configuration screens.

3.3.4 Language Screen

The *Language* screen provides the ability to display English, German, French, Portuguese, and Spanish on the front panel.

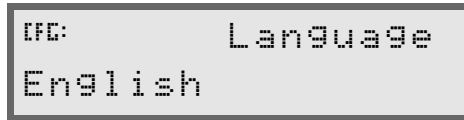

To change the display language:

1. Press .
2. Press  or  to select the desired language.
3. Press .

The screen automatically displays the configured language.

4 Configuring the AgGPS 114 Receiver

This chapter shows you how to:

- Setup the AgGPS 114 receiver for satellite DGPS service
- Configure port parameters for communication with another device

We recommend you read through this chapter before attempting to configure your AgGPS 114 receiver.

4.1 Configuring the AgGPS 114 Receiver



The Satellite Differential operating parameters are not set from the factory. These settings have to be configured to allow the AgGPS 114 receiver to be used immediately after installation. You can use the AgRemote software's front panel to change configuration parameters and activate satellite differential services.

The navigation map for the AgGPS Configuration menu and screens is shown in the fold-out pages in Appendix I. Fold out the second page and use it for reference while accessing the screens described in this chapter.





4.1.1 Using the AgRemote Software to Change Configuration Settings

For more information, see Getting Started, page 3-1, Using AgRemote.

To use a typical configuration screen:

1. From the *Home* screen, navigate to a *Configuration* screen and click .
2. Click  to cycle through the *Configuration* screens.
3. Click  to activate the configurable options.

The first setting option flashes.

4. Click  or  to cycle through the available settings. If there are multiple settings on a single screen, click  to activate the next setting.
5. When all settings are complete, click .
6. Click  to display the next *Configuration* screen.





4.2 Satellite DGPS Activation Configuration

DGPS Configuration screens determine which differential service provider the AgGPS 114 receiver uses. When using the AgGPS 114 receiver, only the Satellite DGPS screen set is available.



Note – The AgGPS menu system supports both Beacon DGPS and Satellite DGPS configuration and status screen sets. The appropriate configuration and status screen set is automatically selected for each receiver product. The AgGPS 114 receiver uses the Satellite DGPS configuration and status screen set (not the Beacon DGPS screen set).

To display the main menu *DGPS Configuration* screen:

1. From the *Home* screen, click  until the *Configuration* screen appears.
2. Click  until *GPS Config* screen appears.
3. Click  until *DGPS Config* appears.
4. Click  until *DGPS Source* screen appears.

4.2.1 DGPS Source

When using an AgGPS 114 receiver, the DGPS Source setting determines what type of differential corrections are applied. The AgGPS 114 receiver defaults to satellite differential. The *DGPS Source* screen is shown below:



```
DE:   DGPS Source
      Satellite Only
```

Table 4-1 describes the DGPS source settings.

Table 4-1 DGPS Source Settings

Setting	Description
Satellite Only	Satellite DGPS corrections are used (subscription must be activated to receive data).





4.2.2 Easy Satellite DGPS Configuration

The *Easy Satellite DGPS Configuration* screen automatically sets the satellite frequency and baud rate based on the location specified. Enter your location and the receiver knows what frequency and baud rate to use.



```
OE: EZ Sat:  XXXXX
N. America East
```

When you obtain your satellite subscription, the service provider tells you which satellite coverage beam to choose. To enter the provider and select the desired beam:

1. Click .
2. Click  until your provider is listed (Omni* or Racal)
3. Click .
4. Click  until your location is displayed.
5. Click  to accept and save.

4.2.3 Satellite Frequency







Tip – The *Satellite Frequency* and *Satellite Baud* screens are only used when the satellite frequency is not found under the *Easy Satellite DGPS Configuration* screen. This can occur when the DGPS provider changes frequency or baud rate after the release of the receiver firmware.

To apply corrections from a satellite differential service, you can manually enter the appropriate satellite beam frequency. Change the satellite beam frequency *only* when instructed by the DGPS provider. The *Satellite Freq* screen is shown below:

```
00: Satellite Freq
1556.2550 MHz
```

To set the differential service satellite frequency:

1. Click .
- The first configurable number flashes.
2. Click  or  to change the value.
3. Click  to highlight the next configurable number.
4. Continue until the proper frequency is set, then click .

The satellite frequency depends on your geographic location and differential service provider. For a listing of local satellite frequencies, contact your differential provider.

Two differential service providers are available for use with the AgGPS 114 receiver.

Contact OmniSTAR at: 888-883-8476.

Contact Racal-LandStar at: 888-434-7757.

4.2.4 Satellite Baud

The satellite baud must match the output rate set by your differential provider. The satellite baud screen is shown below.

```

[00: Satellite Baud
 1200 bps

```

Available baud rates are 600, 1200, and 2400.

4.2.5 OmniSTAR Activation

This setting contains a 24-digit OmniSTAR satellite differential service activation code. The *Omni** screen is shown below.

```

[00:Omni*0000000000
0000000000000000

```

To activate the OmniSTAR satellite differential service, see Appendix F.



Note – If a receiver is activated automatically over-the-air, the OmniStar activation code will not be displayed.



Note – If an incorrect number (such as all zeros) is input, retry using the correct activation code. Incorrect codes have no effect on receiver operations.

4.3 Racal Solution

In some locations, Racal network DGPS solutions are not available. In these locations the corrections can be received from the nearest reference station. The *Racal Stations* screen is shown below:

```

RAC:      Racal Stns
Use Network Stn
  
```

Table 4-2 describes the Racal Station settings.

Table 4-2 Racal Station Settings

Setting	Description
Use Network Stn	Uses corrections from the Racal Network. These corrections are usually more accurate than from a single station.
Use Closest Stn	Uses corrections from the closest reference station. These solutions are necessary if you are located outside the network range.



4.4 Configuring Port Parameters



Note – Ports A & B can simultaneously communicate in both RS232 and CAN. The port parameter screens configure RS232 messages.

Port A & B must be configured to make sure the proper data type is input and output from the AgGPS 114 receiver. The configuration of Port A and Port B is identical; therefore, only Port A is discussed in this chapter. Refer to Chapter 2, Section 2.4, Routing and Connecting the AgGPS 114 Data/Power Cable for explanation of the port A & B physical connections.

To display the *Port A Configuration* screen:

1. From the *Home* screen, click  until the *Configuration* screen appears.
2. Click  until *GPS Config* screen appears.
1. Click  until the *Port A Configuration* screen appears.



```
Config Port A
Press v to Enter
```

2. Click  to cycle through the screens. *Port A configuration* screens are described in the following sections.

4.4.1 Setting the Port Input /Output Parameters

Port input parameters are important when communicating with the AgGPS LightBar and other external devices. The *Port-A Input* screen is shown below:

```

CFG: I   RCTM   9600
8-N-1 0 NMEA 4800

```

Table 4-3 describes the Port input parameter settings.

Table 4-3 Port Input Parameter Settings

Setting	Description
None	Nothing is input.
TEXTB	ASCII data from an external device, such as a chlorophyll meter, can be input on Port A, merged with NMEA GPS data, and output on Port B. The incoming data must be limited to 66 ASCII characters and must be terminated by a carriage return and line feed (hex characters 0x0D 0x0A). The NMEA string outputs as \$PTNLAG001,<up to 66 ASCII characters>*<2 digit checksum><CR><LF>. To output the combined NMEA string, NMEA must be selected as the output protocol on Port B.
TEXTA	See the description for the TEXTB setting. TEXTA inputs on Port A, not Port B.
RTCM	Inputs RTCM data from an external DGPS device, such as an FM pager.
TSIP	Inputs TSIP data packets from the port when using the optional AgRemote software or using the AgGPS 70 Remote Data Logger.
LBAR	Inputs data from the AgGPS LightBar. This setting is required when using the AgGPS Parallel Swathing Option.

The remaining settings configure baud rate, data bits, stop bits, and parity. The output defaults are 4800, 8-N-1.

4.4.2 NMEA 1 Settings





When NMEA data is selected as the port output setting, you can change the selection of NMEA messages output by the receiver. The default messages are GGA, GSA, VTG, and RMC.

The Port A *NMEA-1* screen is shown below:



```
00: NMEA-1 GGA 911
VTG 9sv GSA zda
```

To change the NMEA messages output:

1. Click . The first three-letter NMEA message type flashes.
2. Click  or  to change the capitalization of the NMEA message type. **When capitalized, the NMEA message is output. Lower case NMEA message types are not output.**
3. Capitalize the NMEA message(s) to be output, and click  when you are finished.



Note – More NMEA data types are available on the Port A and Port B *NMEA-2* and *NMEA-3* screens.

4.4.3 NMEA 2 Settings

The settings on the Port A *NMEA-2* screen are extensions of the options found on the Port A *NMEA-1* screen. Four NMEA screens are required to present all of the NMEA options. Capitalized NMEA data types on both the *NMEA-1* and *NMEA-2*, *NMEA-3*, and *NMEA-4* screens are output. The Port A *NMEA-2* screen is shown below:

```
DE: NMEA-2 RMC mss  
Ptnlid Ptnldg
```

4.4.4 NMEA 3 Settings

The settings on the Port A *NMEA-3* screen are extensions of the options found on the Port A *NMEA-1* and *NMEA-2* screens. Capitalized NMEA data types on each NMEA screen are output. The Port A *NMEA-3* screen is shown below:

```
DE: NMEA-3 grs gst  
Ptnlsm Ptnl99k
```



Tip – For detailed information about content and structure of NMEA messages, see Appendix D.

4.4.5 Message Rate

This setting can be used to vary the NMEA and TSIP output rate. For example, if the Parallel Swathing Option was purchased, lightbar data is output at a rate of 5 times per second (5 Hz). Meanwhile, on the other port, NMEA or TSIP data can be output to a computer software package, yield monitor, variable rate controller, or other equipment at a slower rate.

The message rate screen is shown below:

```
CFG: NMEA out 1 Hz
      TSIP out 1 Hz
```

To modify the port output rate, select the NMEA or TSIP message and choose the required rate. ASAP equals the rate selected on the *PV Filter and Position Rate* screens under the *GPS Config* screen. A setting of *1* outputs a position once every 1 second. A setting of *ASAP* outputs positions 5 or 10 times every second. Refer to Appendix G to learn how to setup the AgGPS 114 receiver for fast rate position output.



Warning – No messages are output unless the message type is selected in the *Port Output* screen.

5 Troubleshooting

This chapter covers frequently asked questions and troubleshooting techniques for the AgGPS 114 receiver. Trimble recommends you read through this chapter before calling technical support.

5.1 Increasing GPS Accuracy

The AgGPS 114 receiver always gives the most accurate position under the current GPS, satellite differential operating conditions. By manipulating various GPS masks, some satellite configurations are locked out, preventing less accurate positions from being computed. However, these changes can prevent positions from being output.

If your GPS application can tolerate occasional outages, then more accuracy is possible by changing the various GPS receiver parameters from their default values.

There are many GPS receiver parameters that affect accuracy:

- **Elevation Mask**
The default Elevation Mask is 8°. Raising this mask prevents the receiver from using some low elevation satellites, often a source of inaccurate positions.
- **Signal Strength Mask**
The default Signal Strength Mask is 6. Increasing the signal strength mask prevents the use of weaker GPS signals that contribute to inaccurate positions.

- **PDOP Mask**
The default PDOP Mask is 6. Lowering this mask ensures the receiver uses only satellite constellations that provide the highest accuracy.
- **GPS Mode**
The default GPS position mode is Auto 2D/3D. Three-dimensional positions are more accurate than two-dimensional positions, so changing the receiver to Manual 3D prevents 2D positions from being computed.
- **DGPS Mode**
The DGPS mode default setting is DGPS Auto/On/Off. Selecting DGPS Only, restricting the receiver to only output differential GPS positions, prevents autonomous (non-differential) positions from being computed.

A relatively uncontrolled source of position inaccuracy is multipath noise, caused by reflections of the GPS signals from nearby buildings and flat surfaces. For best accuracy, mount the GPS receiver so it has a clear view of the sky. Accuracy is best when operating away from buildings and trees.

5.2 Intermittent GPS Loss

When GPS lock is intermittent, the power/data cable may have a loose connection. Check that all connections are secured properly. Water may enter the cable connection and cause intermittent loss of lock. Disconnect the cable and let the connection dry. Reconnect the cable.

If the receiver is connected properly, make sure that it is mounted on the highest point of the vehicle, so that no GPS signals are blocked. Depending on the orientation of the vehicle, the satellites and the possible obstruction, one or more satellites may be blocked. Sometimes blocking shows up when traveling one direction, but not when traveling other directions.

If the receiver seems fine, check the configuration masks. If the PDOP or SNR Masks are set to extreme levels, the receiver could possibly ignore valid satellite data. The default SNR Mask is 6. The default PDOP Mask is 6.

5.3 Power Lines and Strong Magnetic Fields

In North America, the energy from power lines is 60 Hz (50 Hz in Europe). The harmonic energy falls off rapidly as the frequency increases. Thus, power lines have very little effect on the GPS & Satellite Differential Signals.

Strong magnetic fields have no effect on GPS & Satellite Differential signals. Some computers and other electric equipment radiate electromagnetic energy that can interfere with a GPS receiver. If you suspect interference from a local magnetic field, move the receiver away from, or turn off the suspect electronics while observing the GPS receiver's number of satellites being tracked or satellite's signal-to-noise ratio.

5.4 Choosing an Mounting Location

The receiver must be mounted so that it has a clear view of the sky, on the center line of the vehicle, away from any sources of interference like electric motors. See Choosing a Location, page 2-4.

5.5 Checking for Cable Failure

To check a cable for a short, use an ohmmeter. The resistance of a good cable between connector pins at each end of the cable, is zero.

If the cable checks out fine, but you are confident it is the cable causing the errors, swap out the cable with another known working cable (if possible).

If the cable is defective, contact your local Trimble dealer for an RMA # (if warranty) or to purchase a replacement cable.

5.6 Reducing Engine Noise

An unshielded ignition system can radiate enough noise to block reception of the beacon signal. To solve this problem, use resistor spark plug wires. Sometimes an alternator generates noise that interferes with the beacon. Use bypass capacitors, commonly available in automotive stores for cleaning up interference to CB and other radios. If the problem persists, engine components can be shielded with aluminum foil.

Before purchasing new engine parts, make sure that there is not a PC computer or power source near the AgGPS 114 receiver. Some PCs and their power sources generate noise that is disruptive to the GPS & satellite DGPS signals.

5.7 Why Satellite DGPS Works in Some Places But Not Others

Local canopy cover in the direction of the differential satellite can reduce the correction signal strength to unusable levels. Wet canopy reduces signals even more. The same local environmental factors that affect GPS signals, such as radar sets, microwave transmitters, and the like can interfere with the differential satellite signals.

Differential satellite signals are line-of-sight. This complicates the use of satellite corrections in mountainous regions, especially at higher latitudes when the satellite view angle is closer to the horizon.

5.8 Verifying the Unit is Outputting NMEA Messages

Connect the AgGPS 114 receiver to a PC with the Standard Data/Power Cable (P/N 30945) and use Windows 95/98's Hyperterminal program to view the NMEA messages input through your computer's serial port. The default NMEA parameters are 4800-N-8-1. View the lat/long changes on your yield monitor.

5.9 Losing Configuration Settings When the Receiver is Powered Off

The AgGPS 114 receiver configuration parameter settings are stored in battery-backed RAM (random access memory). The Lithium battery has a 10-year life span. You can assume the Lithium battery has failed when the receiver no longer retains configuration parameter setting changes.



Note – The receiver can continue to use the default configuration parameters, but does not retain any custom changes to the default settings after it is powered off.



Contact Trimble Navigation Precision Agricultural Systems Technical Support Service to arrange for replacement of Lithium batteries.

5.10 Restoring the Receiver to Factory Defaults

To restore the receiver configurations to factory defaults:

1. Connect the Ag114 to a computer. Make sure the Ag114 is powered.
2. Run the AgRemote software program.
3. From the *Home* Screen, click the  arrow until *Clear BB Ram* screen appears.

The receiver asks if you want to “Clear BB Ram”.

4. Click  or  until the display reads yes.
5. Click .

The receiver returns to factory defaults. The Satellite DGPS service subscription is not lost.

troubleshooting Guides

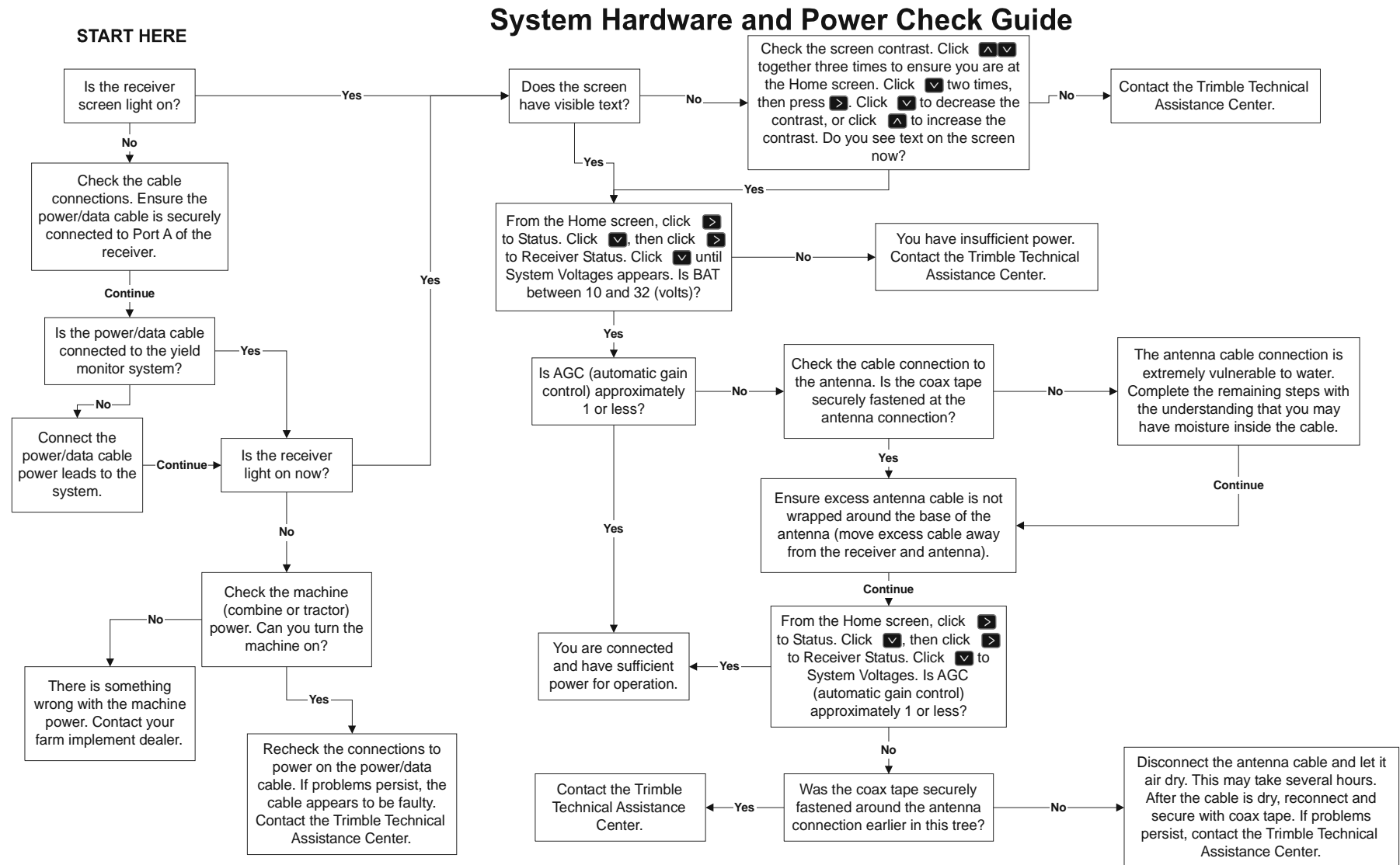

Figure 5-1 System Hardware and Power Check Guide

GPS Reception Troubleshooting Guide

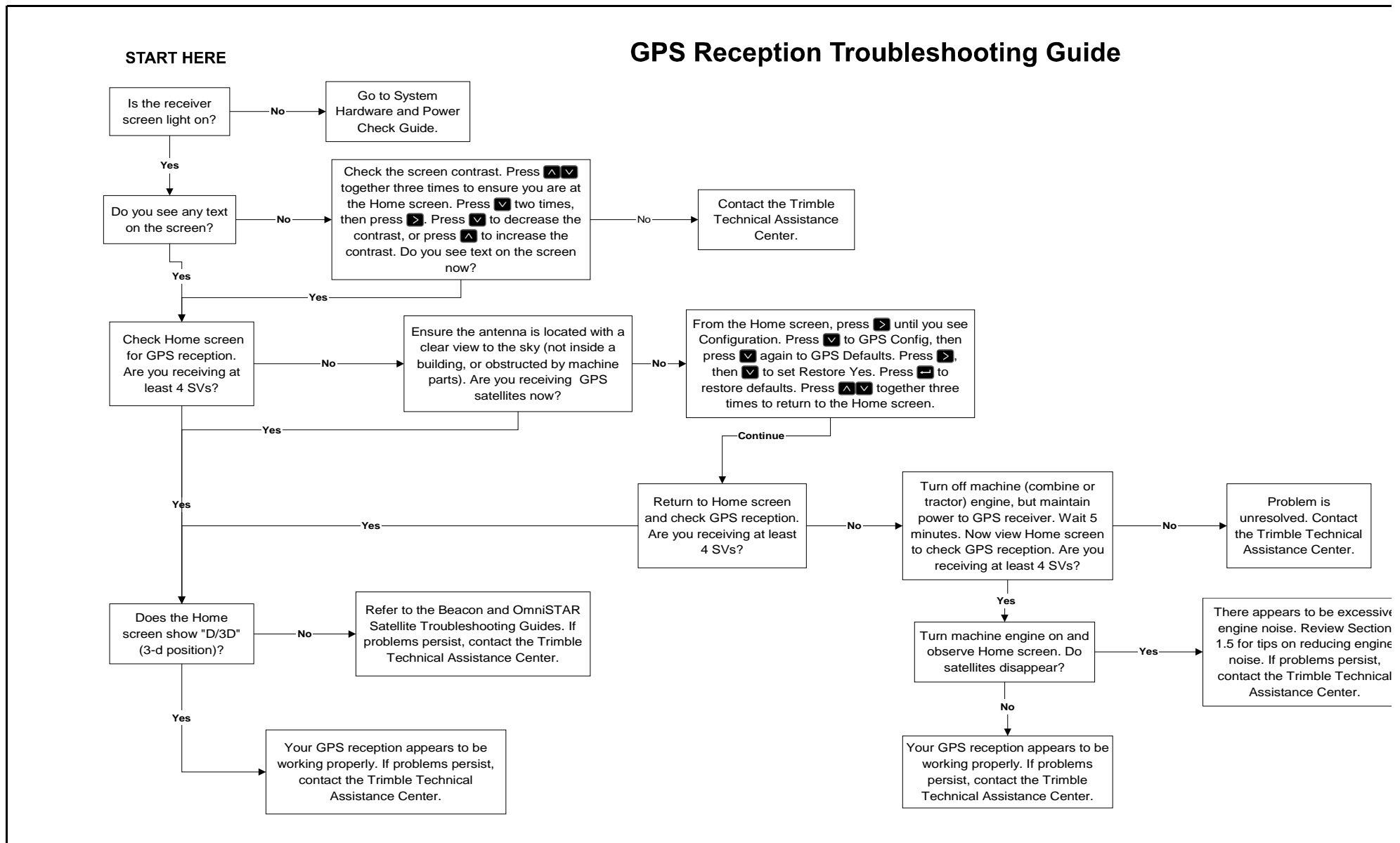

Figure 5-2 GPS Reception Troubleshooting Guide

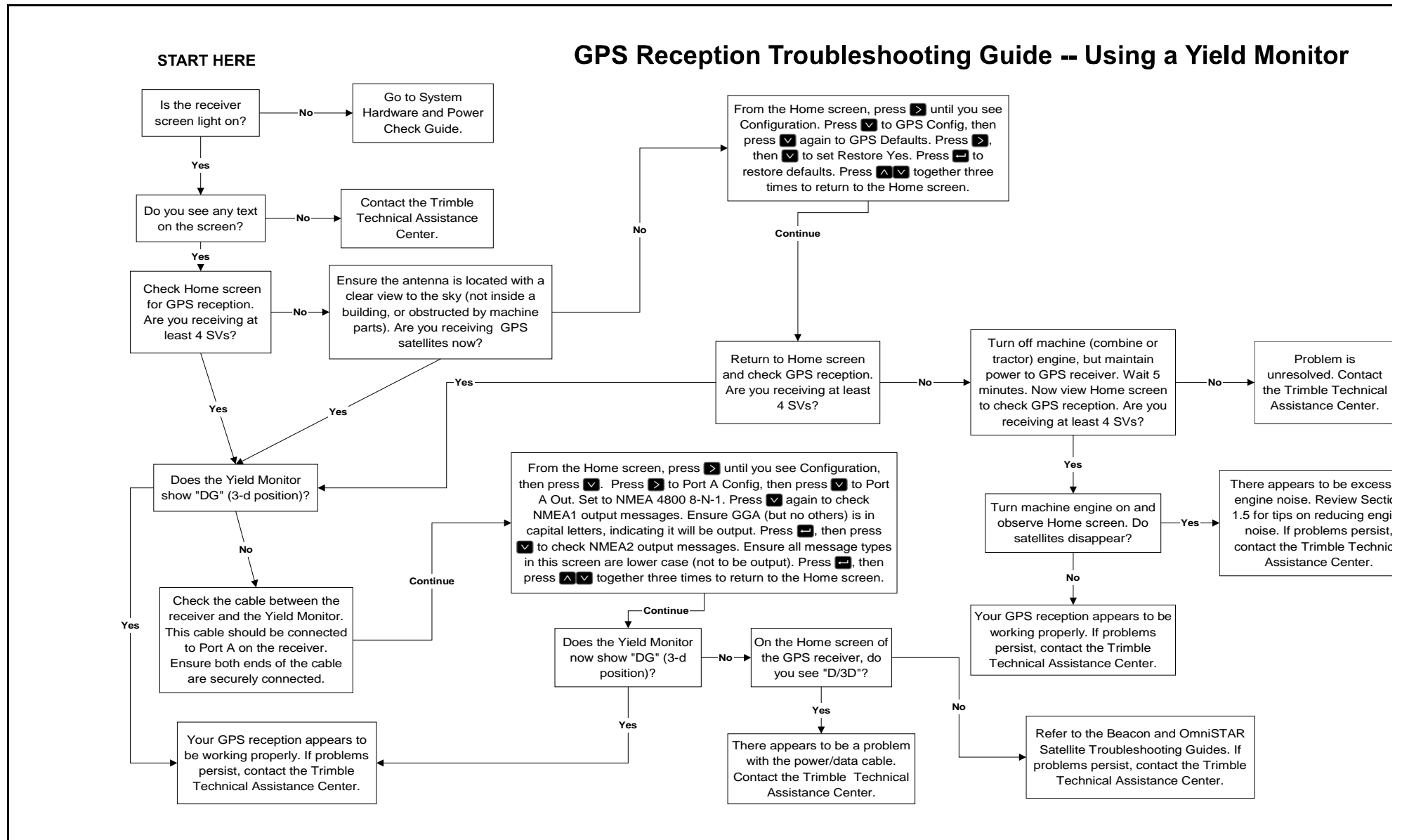

Figure 5-3 GPS Reception Troubleshooting Guide - Using a Yield Monitor

AgGPS 132 Only

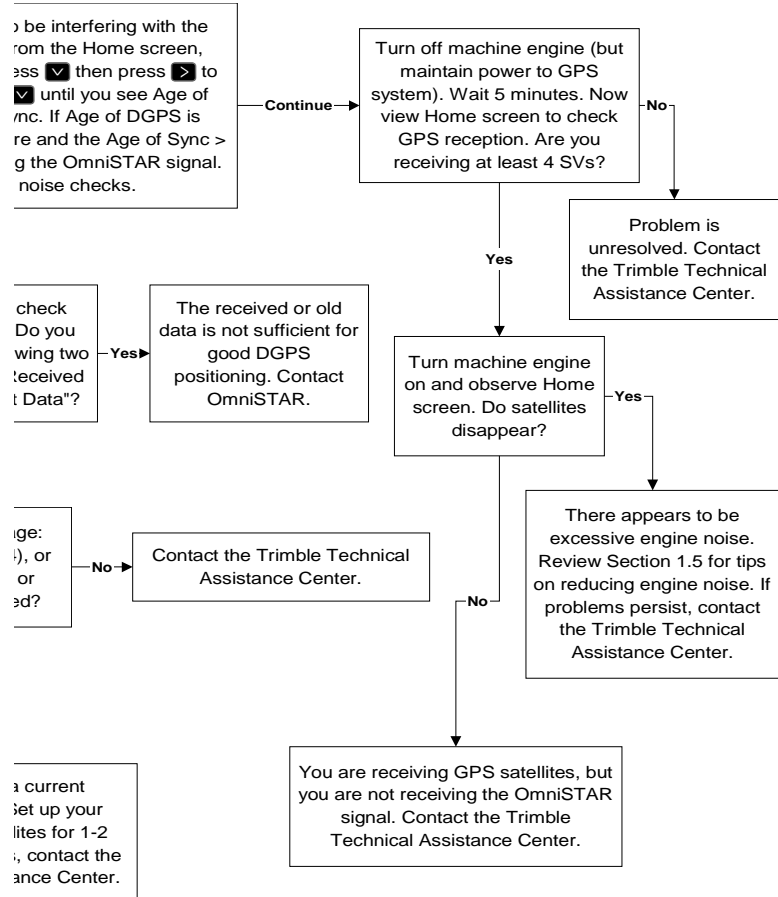

Figure 5-4 OmniSTAR Troubleshooting Guide

e -- AgGPS132 Only

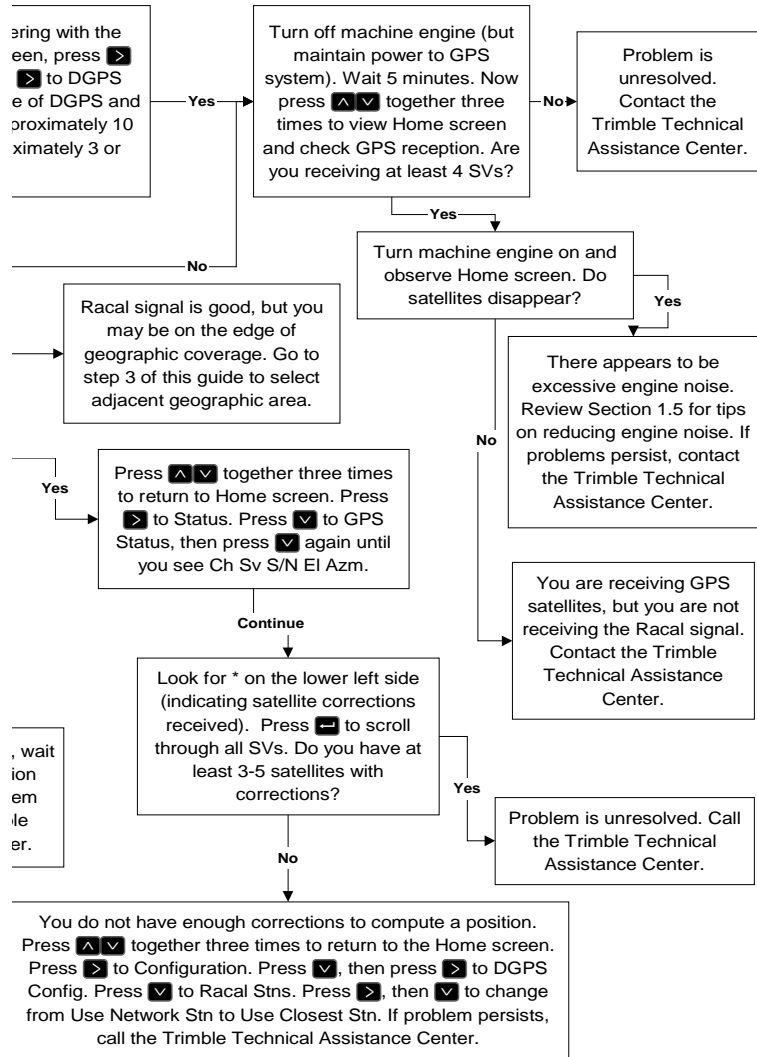

Figure 5-5 Rascal-LandStar Troubleshooting Guide

A Specifications

Table A-1 lists the physical characteristics of the AgGPS 114 combined GPS/DGPS receiver and antenna.

Table A-1 AgGPS 114 Receiver

Size	6 in. Diameter x 5 in. Height, (15.24mm D x 12.7 mm H)
Weight	22oz (0.52kg)
Power	3.1 Watts, 9–32 VDC
Operating Temperature	–30°C to +60°C
Storage Temperature	–40°C to +80°C
Humidity	100% condensing, unit fully sealed
Casing	UV Resistant Plastic, Dust-proof, waterproof, shock resistant
Compliance	FCC Class B, CE, EP 455

Table A-2 list the performance characteristics of GPS channels.

Table A-2 GPS Channels

General	12-channel, parallel tracking L1 C/A code and carrier phase filtered measurements and multi-bit digitizer
Update Rate	1 Hz standard; 10 Hz optional
Differential Speed Accuracy	0.1 MPH (0.16 KPH)
Differential Position Accuracy	Less than 1 meter horizontal RMS; At least 5 satellites, PDOP < 4 and RTCM SC-104 standard format broadcast from Trimble 4000RSi or equivalent reference station
Time to First Fix	< 30 seconds, typical
NMEA Messages	ALM , GGA, [†] GLL, GSA, GST, [†] GSV, GST, MSS, PTNLDG, PTNL, PTNLEV, PTNLID, .PTNLISM, RMC, [†] VTG, XTE, ZDA
[†] By default, the AgGPS 114 receiver is configured to output GGA, GSA, VTG, and RMC messages.	

Table A-3 lists the characteristics of the L-Band Satellite Differential Correction Receiver with Multiple Vendor Support.

Table A-3 L-Band Satellite Differential Correction Receiver with Multiple Vendor Support

Bit Error Rate	10^{-5} for Eb/N of >5.5 dB
Acquisition and Reacquisition Time	<2 seconds, typical
Frequency Band	1525–1560 MHz
Channel Spacing	.5 kHz

B Receiver Defaults

Table B-1 lists the default settings for the AgGPS 114 receiver.

Table B-1 Receiver Defaults

DGPS Source	Satellite
Dynamics	Land
Elevation Mask	8°
SNR Mask	6
PDOP Mask	12
PDOP Switch	8
DGPS Mode	Auto On/Off
DGPS Age Limit	30 sec
Pos Fix Rate	1 Hz

C Cables and Connectors

The tables and drawings in this appendix give pin-out information for the AgGPS 114 standard and optional cables. This information can be used to troubleshoot communication problems with the AgGPS 114 receiver and devices not supported by the *standard* and *optional* cables.

The following drawings show pinout requirements for the *standard* and *optional* cables available for the AgGPS 114 receiver.

C.1 AgGPS 114 Power/Data Cable (PN 40947)

Table C-1 gives pin-out requirements for the AgGPS 114 Power/Data Cable Port A and Port B Connectors.

Table C-1 Ag114 Power/Data Cable (PN 40947) Port A (9-Pin) & Port B (12-Pin) Connectors

P1 Conn 12-Pin (F)		Direction	P2 Conn DE-9 (F)		7 Cond Cable	P3 Conn 12-Pin (M)		Red/Black
Pin	Signal		Pin	Signal	Color	Pin	Signal	Wires
1	EVENT IN	←	4	EVENT	Brown			
2	TX	→	2	RXD	Yellow			
3	RX	←	3	TXD	Orange			
4								
5	SIG GND					5	GND	
6	TX	→			Green	2	RX	
7								
8	RX	←			Blue	3	TX	
9								
10	V+	←			Red	10	V+	Red V+
11	V-	←	5	GND	Black	11	V-	Black V-
12								

- 1 Pins 5 and 11 of connector P1 are jumpered together.
- 2 Pins 5 and 11 of connector P3 are jumpered together.
- 3 Pins 7 and 10 of connector P1 are jumpered together with a 5k Ohm, 1/8 watt, 5% resistor.

C.2 AgGPS 114 PSO Plus Cable (PN 39350)

gives pin-out information for the AgGPS 114 PSO Plus Data/Power Cable (P/N 39350).

Table C-2 AgGPS 114 PSO Plus Cable Pin-out (P/N 39350)

P1 Conn AgGPS 114			7 Cond Cable	P2 Conn Lightbar		7 Cond Cable	P3 Conn RDL		Red/ Black	3 Cond Cable
Pin	Signal		Color	Pin	Signal	Color	Pin	Signal	Wires	Color
1							1	EVENT IN		White
2	TX	➔	Yellow			Yellow	3	TXDA		
3	RX	➔	Orange			Orange	2	RXDA		
4										
5	SIG GND	↔		5	GND		5	GND		
6	TX	➔	Green	3	RXDB					
7										
8	RX	➔	Blue	2	TXDB					
9										
10	V+	➔	Red	10	V+	Red	10	V+	Red V+	
11	V-	➔	Black	11	V-	Black	11	V-	Black V-	Black
12		➔		12	Alarm	Blue				Red

- 1 Pins 5 and 11 of the P1 connector are jumpered together.
- 2 Pins 5 and 11 of the P2 connector are jumpered together.
- 3 Pins 5 and 11 of the P3 connector are jumpered together.
- 4 Pins 7 and 10 of the P1 connector are jumpered together with a 5 kOhm, 1/8 watt, 5% resistor.

C.3 Ag Leader Interface Cable (PN 39903)

gives pin-out information for the Ag Leader Yield Monitor Interface Cable (P/N 39903).

Table C-3 Ag Leader Yield Monitor Cable Pin-out (P/N 39903)

P1 Connector 12-pin CONXALL		Direction	7 Cond Cable	P2 Connector DE-9 Male		2 Cond Cable
Pin	Signal		Color	Pin	Signal	Wires
1	EVENT IN	←				
2	TX-	→	Orange	3	RXD	
3	RX-	←	Blue	2	TXD	
4	CHG CTRL	←				
5	SIG GND	↔	Shield	5	SIG GND	
6	TX+	→				
7	PWR ON	←				
8	CTS	←				
9	CHARGE	→				
10	V+ IN	←				Red
11	V- IN	←				Black
12	PPS	→				

1 Pins 7 and 10 of the P1 connector are jumpered together with a 5 kOhm, 1/8 watt, 5% resistor.

C.4 Case AFS Cable

Table C-4 gives pin-out information for the Case AFS Dual Data Interface Cable (P/N 32609).

Table C-4 Case AFS Cable Pin-out (P/N 32609)

P2 Connector 12-Pin CONXALL		Direction	5 Cond Cable Color	P1 Connector 5-Pin MetroPack Conn	
Pin	Signal			Pin	Signal
2	NMEA OUT	➔	Blue	D	RXD
3	YIELD DATA	➔	Red	B	TXD
5	DATA GND	↔	Clear	C	DATA GND
10	PWR IN	➔	Green	A	+12 VDC
11	PWR GND	↔	Black	E	PWR GND

- 1 Pins 7 and 10 of the P2 connector are jumpered together with 5 kOhm, 1/8 watt, 5% resistor.

C.5 John Deere GreenStar Data Cable

Table C-5 gives pin-out information for the John Deere GreenStar Data Cable (P/N 34189).

Table C-5 John Deere GreenStar Data Cable Pin-out (P/N 34189)

P2 Connector DE-9 Male		Direction	Color	P1 Connector 3-Pin Metropack	
Pin	Signal			Pin	Signal
2	TXD	➔	Red	A	RXD
3	RXD	➔	Black	B	TXD
5	GND	↔	Blue	C	GND

C.6 RDS Data Power Cable

Table C-6 gives pin-out information for the RDS power data cable (P/N 35142).

Table C-6 RDS Data Power Cable Pin-out (P/N 35142)

P1 Connector 12-Pin CONXALL		Direction	7 Cond Cable #1	P2 Connector DE-9 Male	
Pin	Signal		Color	Pin	Signal
1	EVENT IN	←			
2	TX- (232)	→	Orange	3	RXD
3	RX- (232)	←			
4	CHG CTRL	←			
5	SIG GND	↔	Shield	5	SIG GND
6	TX+ (422)	→			
7	PWR ON				
8	CTS	←			
9	CHARGE	→			
10	V+ IN	←	Red	8	V+
11	V- IN	←	Black	7	PGND
12	PPS	→			

1 Pins 7 and 10 of the P1 connector are jumpered together with 1 kOhm, 1/4 watt, 5% resistor.

D NMEA-0183 Sentences

Trimble receivers can output a selection of NMEA-0183 sentences. NMEA-0183 sentences are normally generated and output to Port A, allowing the receiver to interface with external instruments. Only the NMEA-0183 standard and Trimble proprietary sentences configured using TSIP command packets are described here. Some Trimble products support additional NMEA-0183 standard sentences and Trimble proprietary sentences which cannot be configured using TSIP command packets. These are described separately in the receiver's operation manual.

D.1 NMEA-0183 Sentence Structure

NMEA-0183 sentences are strings of comma-delimited text. Figure D-1 shows the structure of an NMEA-0183 sentence.

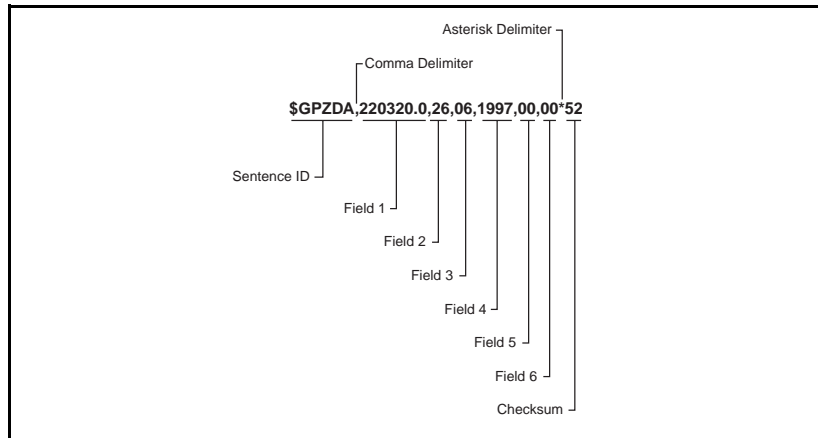

Figure D-1 Sample ZDA Sentence Structure

Each NMEA sentence includes a sentence ID to distinguish the sentence from other NMEA sentences in the data stream. The actual data included in NMEA-0183 sentences is placed in fields. An NMEA sentence contains several fields, and each field is preceded by a comma character. The sample sentence in Figure D-1 contains six fields. The NMEA sentences include a checksum value which is useful for checking the integrity of the data included in the sentence.

The sentence structure of the sample ZDA sentence, shown below and the sentence fields are described in Table D-1.

\$GPZDA,220320.0,26,06,1997,00,00*52

Table D-1 Sample ZDA Sentence Structure

Field	Description
1	Time, in UTC. (220320.0 in the sample sentence)
2	Day, 01 to 31. (26 in the sample sentence)
3	Month, 01 to 12. (06 in the sample sentence)
4	Year. (1997 in the sample sentence)
5	Local time zone offset from GMT, 00 to ± 13 hours. (00 in the sample sentence)
6	Local time zone offset from GMT, minutes. Fields 5 and 6, together, yield the total offset. For example, if field 5 is '-5' and field 6 is '15', local time is 5 hours and 15 minutes earlier than GMT. (00 in the sample sentence)

The NMEA-0183 sentence examples in this chapter are presented in the format shown in Table D-1. The structure of each sample sentence is shown in the paragraphs preceding the sentence structure table.

The numbers in the Field column represent the sentence fields in left-to-right order. Field 1 is the first field following the first comma delimiter. In the sample sentence, field 1 contains the UTC Time value (220320.0). The last field in the sentence is preceded by the last comma in the sentence (00 in the sample sentence).

D.1.1 Symbols and Delimiters

All sentences conform to the NMEA-0183 Version 2.1 format. Symbols and delimiters are used to identify or separate the various kinds of data included in the sentence.

NMEA-0183 sentences always begin with a dollar sign character (\$) followed by a talker ID code and a sentence ID code. For the sample ZDA sentence, GP IS THE TALKER ID, AND ZDA is the sentence ID.

The string of comma delimited text immediately following the sentence ID code is composed of fields containing data. Each field is followed by a comma character (,). For the sample sentence, the data fields are shown below:

```
220320.0,26,06,1997,00,00
```

The first field contains the UTC time value (220320.0), the second field contains the Day value (26), and so on.

NMEA-0183 sentences include a checksum value which is preceded by an asterisk character (*). For more information about checksum values, see Checksum Values, page D-4.

NMEA-0183 sentences are always terminated with a carriage return and line feed. The carriage return and line feed pair marks the end of the sentence.

D.1.2 Checksum Values

Newer Trimble receivers conform to NMEA-0183 Version 2.1 which states that checksums are mandatory for all sentences. Checksum values are always included in output sentences, but are optional for input sentences.

Checksum values are used to verify the integrity of the data included in the sentence. The sample sentence, shown in Table D-1, includes a checksum value. An asterisk character (*) is used to delimit the last data field from the checksum value (52 in the sample sentence).

The checksum is the 8-bit exclusive OR of all characters in the sentence, between but not including the '\$' and '*' delimiters. Commas are also included. The hexadecimal result is converted to two ASCII characters (0-9, A-F). The most significant character appears first.

D.1.3 Field Formats

The data values included in fields meet the format specifications established for the NMEA-0183, Version 2.1 standard.

D.1.4 Null Fields

Null fields are included in some NMEA sentences when no data is available for a particular field. Null fields are empty and are usually reserved for transmitting data on a periodic or irregular basis. The comma delimiter for the Null field is immediately followed by the comma delimiter for the next field in the sentence string.

The inclusion of Null fields in a sentence is important because many NMEA sentences contain a fixed number of fields. NMEA sentence interpreters (software for processing NMEA sentences) expect to find a fixed number of fields in these sentences, and specific kinds of data in each field. The sentence processing software assumes that no data is available for a particular field when a Null field is encountered while interpreting a sentence.

D.1.5 Talker ID Codes

The Talker ID code identifies the source of the data (GPS, Loran C, Sounder, etc.). The NMEA-0183 standard defines 35 Talker ID codes. The Talker ID codes available for NMEA-0183 output from the most Trimble receivers are described in Table D-2.

Table D-2 Supported Talker ID Codes

Code	Description
GP	GPS
LG	Loran C/ GPS
LC	Loran C
II	Integrated Instrumentation

D.1.6 Latitude and Longitude Values

The latitude and longitude values included in NMEA sentences are presented in degrees, minutes, and decimal minutes. Latitude is presented as *ddmm.mmmm* in a single field, and longitude is presented as *dddmm.mmmm* in a single field. Within the field, degree values are in *dd* or *ddd* format, and minutes and fractions of minutes are in *mm.mmmm* format.

Latitude and longitude direction values (north, south, east, or west) are placed in a separate field. Direction is a single character: ‘N’, ‘S’, ‘E’, or ‘W’ for *North, South, East, or West*.

D.1.7 Time Values

Time values are in UTC (Universal Time Coordinated), and are inserted in sentence strings in *hhmmss.ss* format, where *hh* is hours (from 00–23), *mm* is minutes, and *ss.ss* is seconds and fractions of seconds.

D.1.8 Other Values

The NMEA-0183 standard established the format of the data included in sentence fields.

D.1.9 Reading NMEA String Format

When using NMEA strings, be aware that the strings can be of varying length, depending on how the receiver is configured. Comma delimited parsing is recommended.

D.2 NMEA Sentence Summary

Table D-3 describes the NMEA-0183 sentence set supported by various receivers and identifies the page number where you can find detailed information about each sentence. Some sentences are only supported when specific Trimble options are installed on the receiver. Sentences beginning with PTNL are Trimble proprietary sentences.

Table D-3 Supported NMEA-0183 Sentences

Sentence	Sentence Contents
ALM	GPS week number, SV health, and complete almanac data for one SV. One sentence per SV, up to a maximum of 32
GBS Sentence	GNSS Satellite Fault Detection
GGA Sentence	Time, position, and fix related data
GLL Sentence	Position fix, time of position fix, and status
GRS Sentence	GPS Range Residuals
GSA Sentence	GPS position fix mode, SVs used for navigation and DOP values
GST Sentence	GPS Pseudorange Noise Statistics
GSV Sentence	Number of SVs visible, PRN numbers, elevation, azimuth and SNR values
MSS Sentence	Signal strength, signal-to-noise ratio, beacon frequency, and beacon bit rate
RMC Sentence	UTC time, status, latitude, longitude, speed over ground (SOG), date, and magnetic variation of the position fix
VTG Sentence	Actual track made good and speed over ground
XTE Sentence	Cross-track error
ZDA Sentence	UTC time, day, month, and year, local zone number and local zone minutes.
PTNLAG001 Proprietary Sentence	66 character sentence available when TEXTA or TEXTB are selected as the port input protocol.
PTNLDG Proprietary Sentence	Beacon channel strength, channel SNR, channel frequency, channel bit rate, channel number, channel tracking status, RTCM source, and channel performance indicator.

Table D-3 Supported NMEA-0183 Sentences (Continued)

Sentence	Sentence Contents
PTNLEV Proprietary Sentence	Time, event number, and event line state for time-tagging change of state on a event input line.
PTNL,GGK Sentence	Time, Position, Position Type and DOP Values
PTNLID Proprietary Sentence	Receiver machine ID, product ID, major and minor release numbers, and firmware release date.
PTNLSM	Reference Station Number ID and the contents of the Special Message included in valid RTCM Type 16 records.

D.3 ALM Sentence

(GPS Almanac Data)

The ALM sentence identifies the GPS week, SV health, and contains the almanac for one satellite. The sentence structure is shown below:

```
$GPALM,1,1,03,698,00,6ae6,1d,779f,fdef,a10d
68,6469a6,7c1f62,5f5839,*43
```

Table D-4 identifies the ALM sentence fields.

Table D-4 ALM Sentence Fields

Field	Description
1	Total number of ALM sentences for this cycle
2	Sentence sequence number
3	SV PRN number, 01 to 32
4	GPS week number
5	SV health status
6	Eccentricity
7	Almanac reference time
8	Inclination angle
9	Rate of right ascension
10	Root of semi-major axis
11	Argument of perigee
12	Longitude of ascension node
13	Mean anomaly
14	A f0, clock parameter
15	A f1, clock parameter

D.4 GBS Sentence

(GNSS Satellite Fault Detection)

The GBS sentence is used to support Receiver Autonomous Integrity Monitoring (RAIM). The data structure is shown below:

```
$GBS,183059.30,0.0,0.0,0.0,0.0,0.0*6F
```

Table D-5 describes the GBS sentence fields.

Table D-5 GBS Sentence Fields

Field	Description
1	UTC time of the GGA or GNS fix associated with this sentence.
2	Expected error in latitude. [†]
3	Expected error in longitude. [†]
4	Expected error in altitude. [†]
5	ID number of most likely failed satellite.
6	Probability of missed detection for most likely failed satellite.
7	Estimate of bias, in meters, on most likely failed satellite.
8	Standard deviation of bias estimate.

[†] Expected error in meters due to bias with noise equals 0.



Note – Because the contents of this NMEA message do not change significantly during a 1-second interval, the receiver outputs this message at a maximum rate of 1 Hz.

D.5 GGA Sentence

(GPS Fix Data)

The GGA sentence contains the time, position, and fix related data. The sentence structure is shown below:

```
$GPGGA,151924,3723.454444,N,12202.269777,W,
2,09,1.9,-17.49,M,-25.67,M,1,0000*57
```

Table D-6 identifies the GGA sentence fields.

Table D-6 GGA Sentence Fields

Field	Description
1	UTC of position fix in HHMMSS.SS format
2	Latitude in DD MM,MMMM format (0-7 decimal places)
3	Direction of latitude N: North S: South
4	Longitude in DDD MM,MMMM format (0-7 decimal places)
5	Direction of longitude: E: East W: West
6	GPS Quality indicator 0: fix not valid 1: GPS fix 2: DGPS fix
7	Number of SVs in use, 00-12
8	HDOP
9	Antenna height, MSL reference
10	'M' indicates that the altitude is in meters.
11	Geoidal separation
12	'M' indicates that the geoidal separation is in meters
13	Age of differential GPS data record, Type 1. Null when DGPS not used
14	Base station ID, 0000-1023

D.6 GLL Sentence

(Position Data)

The GLL sentence specifies the position fix, time of position fix, and status. The sentence structure is shown below:

```
$GPGLL,3723.4543,N,12202.2696,W,151933,A*3E
```

Table D-7 identifies the GLL sentence fields.

Table D-7 GLL Sentence Fields

Field	Description
1	Latitude in DD MM,MMMM format (0-7 decimal places)
2	Direction of latitude N: North S: South
3	Longitude in DDD MM,MMMM format (0-7 decimal places)
4	Direction of longitude E: East W: West
5	UTC of position in HHMMSS.SS format
6	Fixed text 'A' shows that data is valid
7	See RMC Sentence, page D-18, row 12.

D.7 GRS Sentence

(GPS Range Residuals)

The GRS sentence is used to support the Receiver Autonomous Integrity Monitoring (RAIM). The sentence structure is shown below:

```
$GPRGS,220320.0,0,-0.8,-0.2,-0.1,-
0.2,0.8,0.6,,,,,,,,*55
```

Table D-8 describes the GRS sentence fields.

Table D-8 GRS Sentence Fields

Field	Description
1	UTC time of GGA position fix
2	Residuals 0: Residuals used to calculate position given in the matching GGA line 1: Residuals recomputed after the GGA position was computed
3-14	Range residuals for satellites used in the navigation solution, in meters



Note – Because the contents of this NMEA message do not change significantly during a 1-second interval, the receiver outputs this message at a maximum rate of 1 Hz.

D.8 GSA Sentence

(GPS DOP and Active Satellites)

The GPS sentence identifies the GPS position fix mode, the SVs used for navigation, and the DOP values. The sentence structure is shown below:

```
$GPGSA,A,3,19,28,14,18,27,22,31,29,,,,,1.7,
1.0,1.3*35
```

Table D-9 identifies the GSA sentence fields.

Table D-9 GSA Sentence Fields

Field	Description
1	Mode M: Manual, forced to operate in 2D or 3D A: Automatic, 3D/2D
2	Mode 1: Fix not available 2: 2D 3: 3D
3-14	ID's of SVs used in position fix (null for unused fields)
15	PDOP
16	HDOP
17	VDOP

D.9 GST Sentence

(GPS Pseudorange Noise Statistics)

The GST sentence is used to support Receiver Autonomous Integrity Monitoring (RAIM). The sentence structure is shown below:

```
$GPGST,220320.0,1.3,0.8,0.5,166.1,0.8,0.5,1.6,*4F
```

Table D-10 describes the GST sentence fields.

Table D-10 GST Sentence Fields

Field	Description
1	UTC time of GGA fix
2	RMS value of the standard deviation of the range inputs to the navigation process (range inputs include pseudoranges and DGPS corrections)
3	Standard deviation of semi-major axis of error ellipse, in meters
4	Standard deviation of semi-minor axis of error ellipse, in meters
5	Orientation of semi-major axis of error ellipse, in degrees from true north
6	Standard deviation of latitude error, in meters
7	Standard deviation of longitude error, in meters
8	Standard deviation of altitude error, in meters



Note – Because the contents of this NMEA message do not change significantly during a 1-second interval, the receiver outputs this message at a maximum rate of 1 Hz.

D.10 GSV Sentence

(GPS Satellites in View)

The GSV sentence identifies the number of SVs in view, the PRN numbers, elevation, azimuth and SNR values. The sentence structure is shown below:

```
$GPGSV,4,1,13,02,02,213,,03,-  
3,000,,11,00,121,,14,13,172,05*67
```

Table D-11 identifies the GSV sentence fields.

Table D-11 GSV Sentence Fields

Field	Description
1	Total number of sentences of this type in this cycle
2	Sentence number
3	Total number of SVs visible
4	SV PRN number
5	Elevation in degrees, 90½ maximum
6	Azimuth, degrees from true north, 000½ to 359½
7	SNR, 00-99 dB (null when not tracking)
8-11	Information about second SV, same format as fields 4-7
12-15	Information about third SV, same format as fields 4-7
16-19	Information about fourth SV, same format as fields 4-7



Note – Because the contents of this NMEA message do not change significantly during a 1-second interval, the receiver outputs this message at a maximum rate of 1 Hz.

D.11 MSS Sentence

(Beacon Receiver Signal Status)

The MSS sentence identifies the status of the beacon signal, including the beacon signal strength, beacon signal-to-noise ratio (SNR), beacon frequency, and beacon bit rate. The sentence structure is shown below:

```
$GPMSS,52.5,23.7,287.0,100*4C
```

Table D-12 describes the MSS sentence fields.

Table D-12 MSS Sentence Fields

Field	Description
1	Signal Strength (SS), dB ref: 1 μ V/m
2	Signal-to-Noise Ratio (SNR), dB
3	Beacon Frequency, 283.5 to 325.0 kHz
4	Beacon Bit Rate (25, 50, 100, 200), bits per second
5	Channel Number



Note – Because the contents of this NMEA message do not change significantly during a 1-second interval, the receiver outputs this message at a maximum rate of 1 Hz.

D.12 RMC Sentence

(Recommended Minimum Specific GPS Data)

The RMC sentence identifies the UTC time, status, latitude, longitude, speed over ground (SOG), date, and magnetic variation of the position fix. The sentence structure is shown below:

```
$GPRMC,184804.00,A,3723.476543,N,12202.2397
45,W,000.0,0.0,051196,15.6,E*7C
```

Table D-13 describes the RMC sentence fields.

Table D-13 RMC Sentence Fields

Field	Description
1	Time: UTC time of the position fix in hhmmss.ss format
2	Status A: Valid V: Navigation Receiver Warning (V is output whenever the receiver suspects something is wrong)
3	Latitude coordinate (the number of decimal places, 0–7, is programmable and determined by the numeric precision selected in TSIP Talker for a RMC sentence)
4	Latitude direction: N = North, S = South
5	Longitude coordinate (the number of decimal places, 0–7, is programmable and determined by the numeric precision selected in TSIP Talker for a RMC sentence)
6	Longitude direction W: West E: East
7	Speed Over Ground (SOG) in knots (0–3 decimal places)
8	Track Made Good, True, in degrees
9	Date in dd/mm/yy format
10	Magnetic Variation in degrees

Table D-13 RMC Sentence Fields (Continued)

Field	Description
11	Direction of magnetic variation E: Easterly variation from True course (subtracts from True course) W: Westerly variation from True course (adds to True course)
12	Mode Indication A: Autonomous D: Differential N: Data not valid

D.13 VTG Sentence

(Course Over Ground and Ground Speed)

The VTG sentence identifies the actual track made good and speed over ground. The sentence structure is shown below:

```
$GPVTG,0,T,,0.00,N,0.00,K*33
```

Table D-14 identifies the VTG sentence fields.

Table D-14 VTG Sentence Fields

Field	Description
1	Track made good
2	Fixed text 'T' shows that track made good is relative to true north
3	Not used
4	Not used
5	Speed over ground in knots (0–3 decimal places)
6	Fixed text 'N' shows that speed over ground is in knots
7	Speed over ground in kilometers/hour (0–3 decimal places)
8	Fixed text 'K' shows that speed over ground is in kilometers/hour



Note – Because the contents of this NMEA message do not change significantly during a 1-second interval, the receiver outputs this message at a maximum rate of 1 Hz.

D.14 XTE Sentence

(Cross-Track Error)

The XTE sentence reports the vessel's cross-track error. The sentence structure is shown below:

```
$GPXTE,A,A,0.050,L,N*5E
```

Table D-15 describes the XTE sentence fields.

Table D-15 XTE Sentence Fields

Field	Description
1	A: Valid (fixed)
2	A: Valid (fixed)
3	Cross-track Error, in nautical miles
4	Direction to Steer L: Left R: Right
5	N:Nautical mile units

D.15 ZDA Sentence

(Time and Date)

The ZDA sentence identifies UTC time, day, month, and year, local zone number and local zone minutes. The sentence structure is shown below:

```
$GPZDA,184830.15,05,11,1996,00,00*66
```

Table D-16 identifies the ZDA sentence fields.

Table D-16 ZDA Sentence Fields

Field	Description
1	UTC time
2	Day
3	Month
4	Year
5	Local Zone Number (– for East Longitude)
6	Local Zone Minutes



Note – Because the contents of this NMEA message do not change significantly during a 1-second interval, the receiver outputs this message at a maximum rate of 1 Hz.

D.16 PTNLAG001 Proprietary Sentence

(Text Message)

The PTNLAG001 sentence is a proprietary Trimble NMEA sentence which sets the 66 character sentence string output when TEXTA or TEXTB are selected as port input options. The sentence structure is shown below:

```
$PTNLAG001,XXXXXXXXXXXXXXXXXXXXXXXXXXXXXXXXXXXXXXXXXXXX
XXXXXXXXXXXXXXXXXXXXXXXXXXXXXXXXXXXXXXXXXXXXXXXXXXXX*XX
```

Table D-17 identifies the PTNLAG001 sentence fields.

Table D-17 PTNLAG001 Sentence Fields

Field	Description
1	66 character text string received when TEXTA or TEXTB is enabled as a port input option

D.17 PTNLEV Proprietary Sentence

The PTNLEV message is a Trimble proprietary message for time-tagging and marking when an event input occurs. If enabled, this event message is output whenever an event is detected. The message structure is shown below:

```
$PTNLEV,184804.00,0*XX
```

Table A-2 identifies the PTNLEV message fields.

Table D-18 PTNLEV Sentence Fields

Field	Description
1	Time: UTC time of the position fix in hhmmss.ss format.
2	Event number, starting with event 0

The PTNLEV message is enabled using TSIP.

D.18 PTNLID Proprietary Sentence

(Trimble Receiver Identity)

The PTNLID sentence is a Trimble proprietary sentence for identifying the receiver's machine ID, product ID, major and minor release numbers, and firmware release date. The sentence structure is shown below:

```
$PTNLID,097,01,XXX,XXX,DD/MM/YY*XX
```

Table D-19 identifies the PTNLID sentence fields.

Table D-19 PTNLID Sentence Fields

Field	Description
1	Machine ID
2	Product ID
3	Major firmware release number
4	Minor firmware release number
5	Firmware release date, in DD/MM/YY format

The PTNLID sentence is enabled using TSIP. If enabled, the sentence is output every 30 seconds.

D.19 PTNLDG Proprietary Sentence

(Trimble DGPS Receiver Status)

The PTNLDG sentence is a Trimble proprietary sentence for identifying the DGPS receiver channel strength, channel SNR, channel frequency, channel bit rate, channel number, channel tracking status, RTCM source, and channel performance indicator for either beacon DGPS or satellite DGPS. The sentence structure is shown below:

```
$PTNLDG , xxx . x , xx . x , xxxxxxxx . x , xxxxxx , xx , x , x , x  
xx * xx
```

The PTNLDG sentence fields are defined in free format with the maximum number of characters in the field indicated in above (i.e. 25 bps displayed as xxx,25,xxx instead of xxx,00025,xxx). Additionally, if a channel is disabled, the channel fields may be null fields (commas only). If more than one channel is available, the sentence should be repeated for each channel. Table D-20 identifies the sentence fields.

Table D-20 PTNLDG Sentence Fields

Field	Description
1	Channel signal strength, in 1 dBuV/m. For beacon, this is the electromagnetic field intensity level. For satellite, this is the ADC input voltage level.
2	Channel signal to noise (SNR) level, in dB
3	Channel frequency, in kHz
4	Channel bit rate, in bits per second (bps)
5	Channel number, 0-99
6	Channel tracking status 0: Channel idle 1: Wideband FFT search 2: Searching for signal 3: Channel has acquired signal 4: Channel has locked on signal 5: Channel disabled
7	Specified channel is used as RTCM source 0: Not used 1: Used
8	Channel tracking performance indicator. For beacon, this is the number of errors in the last 255 words. For satellite, this is the time since last sync, in tenths of seconds ranging from 0-255.

This message can be enabled using TSIP. If enabled, it is output at the NMEA report rate.



Note – Because the contents of this NMEA message do not change significantly during a 1-second interval, the receiver outputs this message at a maximum rate of 1 Hz.

D.20 PTNL,GGK Sentence

(Time, Position, Position Type and DOP Values)

The PTNL,GGK message string is shown below:

```
$PTNL,GGK,172814.00,071296,3723.46587704,N,
12202.26957864,W,3,06,1.7,EHT-6.777,M*48
```

Table D-21 describes the PTNL,GGK sentence fields.

Table D-21 PTNL,GGK Sentence Fields

Field	Description
1	UTC of position fix, in hhmmss.ss format
2	UTC Date of position, in mmddy format
3	Latitude, in degrees and decimal minutes (e.g. dddmm.mmmmmmm)
4	Direction of latitude: N: North S: South
5	Longitude, in degrees and decimal minutes (e.g. dddmm.mmmmmmm)
6	Direction of Longitude: E: East W: West
7	GPS Quality indicator: 0: Fix not available or invalid 1: Autonomous GPS fix 4: Differential, code phase only solution (DGPS)
8	Number of satellites used in GPS solution
9	DOP of fix
10	Ellipsoidal height of fix (antenna height above ellipsoid)
11	M: Ellipsoidal height is measured in meters

D.21 PTNLSM Proprietary Sentence

(RTCM Special Message)

The PTNLSM sentence is a Trimble proprietary sentence for identifying the Reference Station ID and the ASCII Text message included in a RTCM Type 16 Special Message. The PTNLSM message is generated anytime a RTCM stream receives a valid Type 16 Special Message. The sentence structure is shown below:

```
$PTNLSM,0022,This is a message,*.XX
```

Table D-22 describes the PTNLSM sentence fields.

Table D-22 PTNLSM Sentence Fields

Field	Description
1	Reference Station ID number, ranging from 0 to 1023. Leading zeros must be added to fill 4-digit field.
2	ASCII text message sentence contained within the Type 16 RTCM message.

E Flash Loader 100

Flash Loader 100 makes updating the Trimble AgGPS 114 firmware quick and trouble-free. You can also use this utility to review your receiver's configuration, add purchased receiver enhancement options, and, if technical assistance is needed, collect troubleshooting information.



Tip – Flash Loader 100 and the latest AgGPS 114 firmware can be downloaded from Trimble's WWW site. The address is WWW.TRIMBLE.COM/SUPPORT/FILES/INDEX.HTM#AG

E.1 Connecting to the Flash Loader Software

To install the Flash Loader software, do the following:

1. Turn on the computer and run Windows 95/98/2000 or Windows NT4.
2. Select *Run* from the **Start** menu.
3. In the *Run* window, type the following:

C:\<Flash Loader file name>

If you are using a different drive or folder, the pathname may be different.

4. Click .
5. Follow the instructions provided by the Flash Loader 100 Setup program.

To update receiver firmware, do the following:

1. Using the AgGPS 114 Data/Power Cable (P/N 40947), connect the AgGPS receiver to the PC's serial port (usually COM1 or COM2).
2. From **Start**, select the Flash Loader 100 software.
3. Click .

The Flash Loader 100 software detects the receiver and automatically selects the correct port. A message box indicates on which port the receiver is found.

If Flash Loader 100 is unable to detect the receiver, try the following:

- Make sure that the receiver is connected to an available power source.
- Power receiver OFF, then back ON.
- Check all cable connections between the receiver and PC.

Click  again.

E.2 Using Flash Loader 100

The main window in the Flash Loader 100 software displays an options checklist. Once the receiver has been successfully detected, select one or more of the available options. Table E-1 describes each option.

Table E-1 Flash Loader 100 Options

Options	Description
Update Receiver with Password	Enables the <i>Enter Password</i> screen to appear. Enter Trimble supplied passwords to activate receiver enhancements such as Fast Rate, Everest, and the Base Station option.
Download Configuration	<p>Enables two radio button options that determine how the downloaded information is processed.</p> <p>Read into file: Configuration data is written to a specified text file.</p> <p>Review on-screen: The receiver's configuration settings are detailed on the PC computer screen.</p>
Upload New Firmware	<p>When selecting the Upload New Firmware checkbox for the first time, a file dialog appears. In the file dialog:</p> <p>Navigate to the directory where the new receiver firmware file is stored. Only files that have the TNR (Trimble Navigation ROM) extension are displayed.</p> <p>Select the appropriate file and click .</p> <p>Flash Loader 100 checks the firmware file to make sure that it is valid.</p> <p>If the file is found invalid, a warning message appears. The Upload New Firmware checkbox is automatically deselected.</p>
Read Error Log	<p>Writes the error log data, stored in the receiver, to a file for use by Trimble technical support personnel.</p> <p>Use the dialog to change the filename or storage folder.</p>

E.3 Running Flash Loader 100

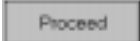
After checking the appropriate options, click  .

The update process will take approximately 5 minutes. Once the process is complete, a message box indicates a successful completion.

If a warning message appears, disconnect the receiver and try again. If the problem persists, contact Trimble Precision Agricultural Systems Technical Support.

F Activating Satellite DGPS Service

This appendix provides step-by-step instructions for activating both OmniSTAR and Racal-LandStar DGPS services.

OmniSTAR Activation

OmniSTAR Activation Guide -- AgGPS 132 Only

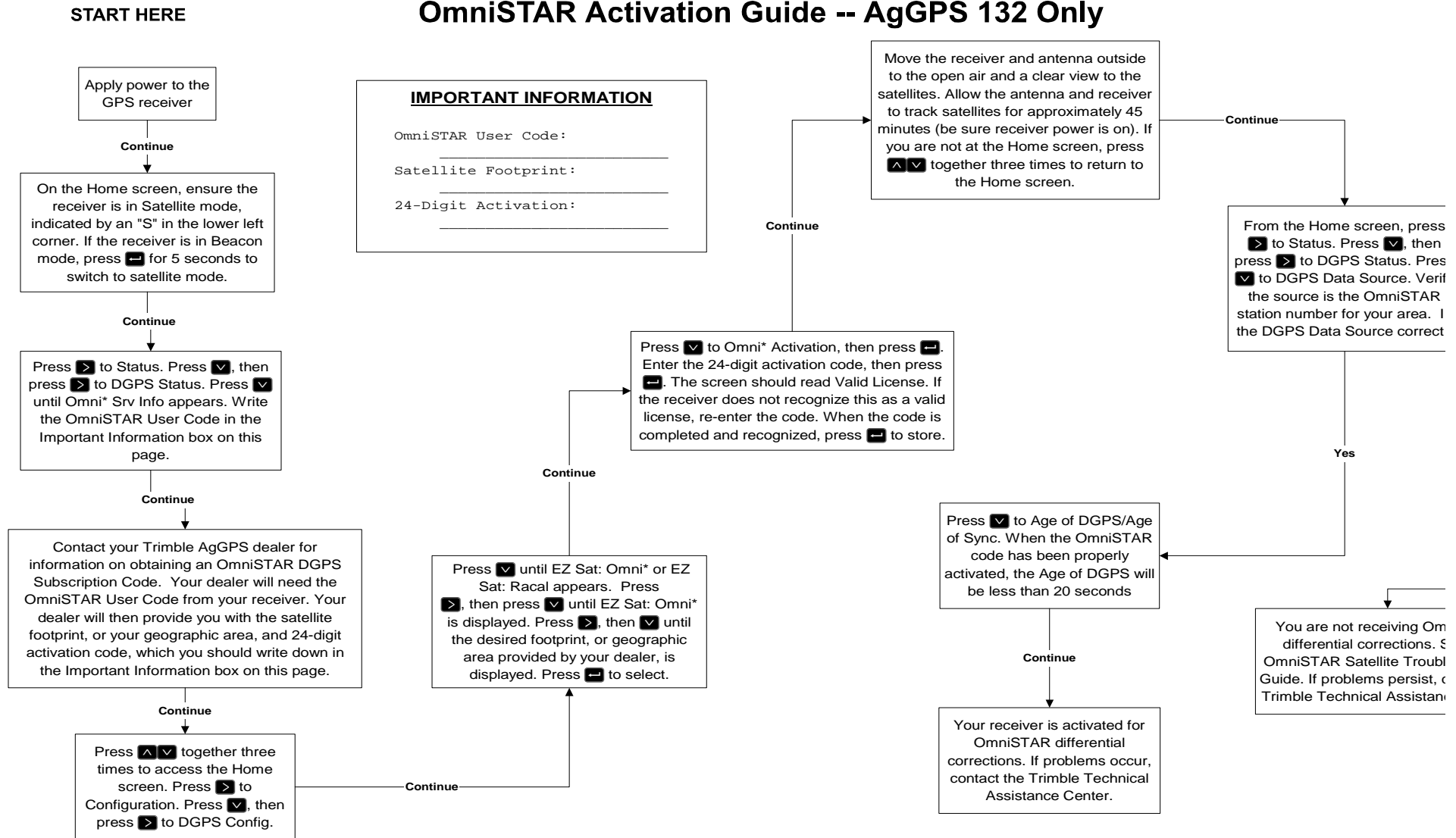

Figure F-1 OmniSTAR Activation Guide

Racal Activation

Racal-LandStar Activation Guide -- AgGPS 132 Only

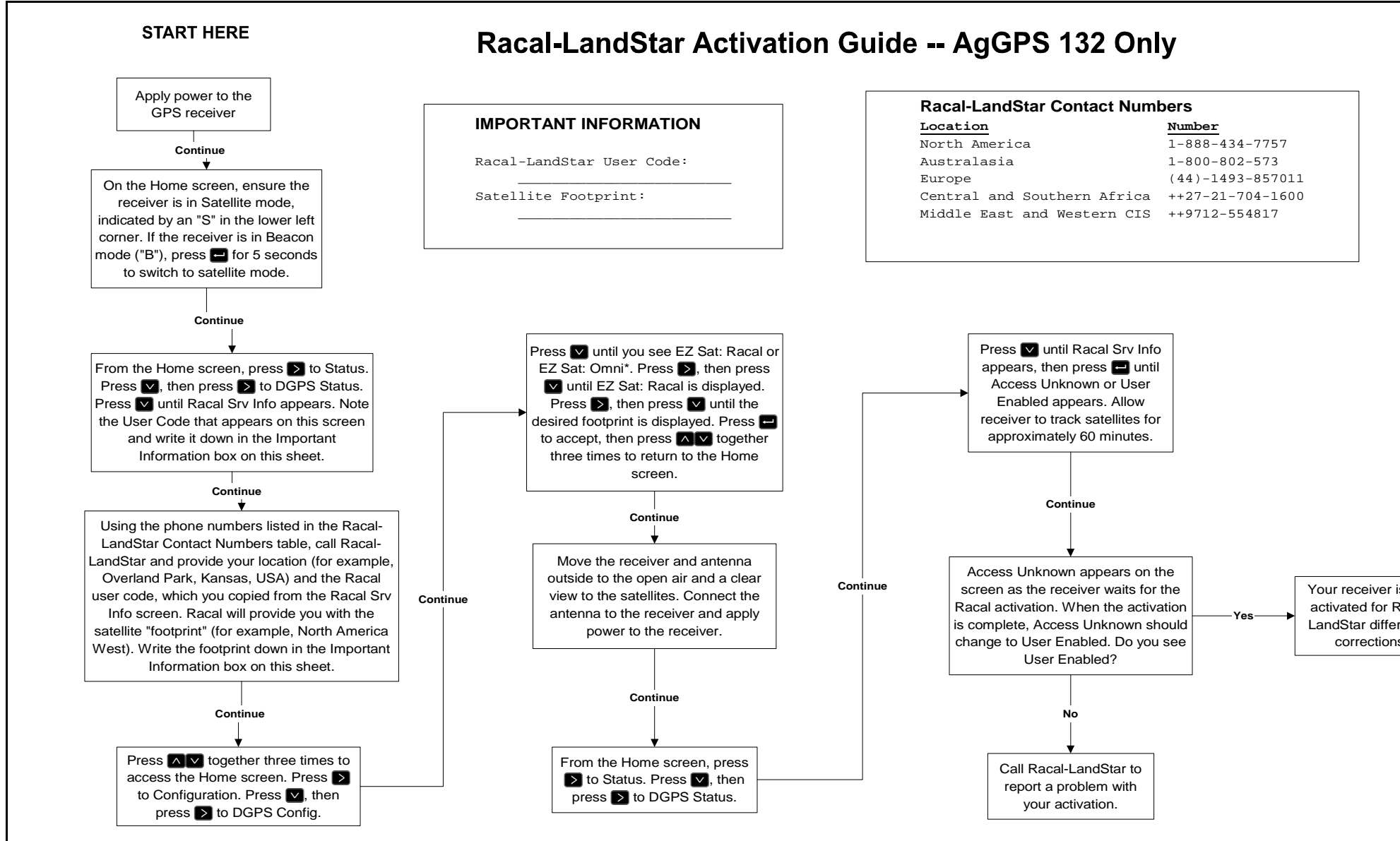

Figure F-2 Racal-LandStar Activation Guide









G Fast Rate Output

These procedures are included for configuring the Fast Rate Option:

- Setting Port A or B for Fast Rate Output
- Configuring the AgGPS 114 receiver for Fast Rate Output

G.1 Setting Port A or B for Fast Rate Output

To set Port A or B for Fast Rate Output using the AgRemote software program:

1. From the *Home* screen, press  until the Configuration appears.
2. Press  until the *Guidance Config* or *GPS Config* screen appears.
3. Press  until the *Port A Config* or *Port B Config* screen appears.
4. Press  until the *NMEA out* screen appears.
5. Press  to activate the cursor. Press  until the cursor flashes on the second numeric digit displayed.
6. Press  until the *ASAP* message is displayed. Press  to save the setting.
7. Press the  key to return to the *Home* screen.

G.2 Configuring the AgGPS 114 Receiver for Fast Rate Output

To configure the AgGPS 114 receiver for fast rate output using the AgRemote software program:

1. From the *Home* screen, press **>** until the *Configuration* screen appears.
2. Press **v** until the *Guidance Config* or *GPS Config* screen appears.
3. Press **>** until the *Pos Rate* screen appears.
4. Press **>** to activate the cursor. Press **>** until the cursor flashes on the second numeric digit displayed.
5. Press **^** to set the output rate. Choose 5 or 10 Hz output rate. Press **←** to save the setting.
6. Press the **Esc** key to return to the *Home* screen.

H Connecting the AgGPS 114 Using AgRemote Software

This appendix includes instructions for:

- Installing the AgRemote Software
- Connecting the AgGPS 114 receiver
- Troubleshooting the AgGPS 114 / computer connection

H.1 Installing the AgRemote Software

To install the AgRemote software, do the following:

1. Turn on the computer and run Windows 95, 98, 2000 or NT4.
2. Select *Run* from the Start menu.
3. In the *Run* dialog, type:

C:\agremote.exe

If you want to use a different drive or folder, specify the desired pathname.



4. Click **Yes** to install the AgRemote program.
5. Follow the instructions appearing on the AgRemote software's Setup screens.

H.2 Connecting the AgGPS 114 Receiver

To connect to the AgGPS 114 receiver, do the following:

1. Using the Standard Data/Power Cable (P/N 40947), connect the right-angle 12-pin conxall connector to the AgGPS 114.
2. Connect the 9-pin female connector to the PC's serial port (usually COM1 or COM2).
3. From the Windows 95, 98, NT, or 2000 desktop, Select *Start / Programs*, and select the AgRemote software option.
4. After the program starts, select *File / Connect*.

The AgRemote program detects the receiver.

5. Click  or  keys to navigate through the menu hierarchy, and configure the AgGPS 114 and Lightbar settings.

H.3 Troubleshooting the Connection

If AgRemote is unable to detect the receiver (screen is blank), try the following:

- Make sure that the receiver is connected to an available 12 VDC power source.
- Check all cable connections between the receiver and PC.
- Click *File / TSIP Break* to force the receiver to communicate the AgRemote software.

I AgGPS Menu System

The figures in this appendix show the navigation maps for AgGPS Menu System, firmware version 1.40.

Basic instructions for navigating through the menu system are included in Chapter 3, Getting Started.

Basic instructions for configuring the AgGPS 114 receiver for operation are included in Chapter 4, Configuring the AgGPS 114 Receiver.

More information about all AgGPS Menu System screens can be found in the *AgGPS Menu System Reference Manual*, included with the AgGPS 114 receiver.

Index

Symbols

(2-12

Numerics

1 pps output 1-12

A

about this manual xv

accuracy

 DGPS 1-4

 factors affecting
 elevation mask 1-5
 environmental factors
 multipath 1-5
 multipath 1-5
 number of visible
 satellites 1-4

 PDOP 1-4

 signal to noise ratio
 (SNR) 1-5

 GPS

 measuring 1-6

activating a satellite DGPS service F-5

 OmniSTAR F-7

 Racal F-9

AgField pack 1-10

AgGPS

 menu system 3-1, 4-1, I-1

AgGPS 114 receiver

 AgRemote software

 using 3-1

 back panel 1-11

 components 2-2

 configuring 4-1

 connections 1-11

 input (ASCII, TSIP,
 RTCM) 1-12

 output (RTCM, TSIP,
 NMEA, 1 pps) 1-12

 enhancements 2-2

 installation 2-1

 guidelines 2-4

 mounting 2-6

 overview 1-1, 5-1

 physical characteristics A-1, B-1

 standard features 1-8

ALM sentence A-2, D-9

almanac D-9

antenna

 cable

 routing, connecting 2-8

 mounting 2-6

 electrical interference 2-7

application options 1-10

AgField pack 1-10
audience xv

C

cable

- CASE AFS Power/Data 2-11
- data interface C-4
- GreenStar data 2-12
- RDS 2-17
- standard data/power 2-10
- Windows CE cable 2-18, 2-19
- Windows CE with cigarette power adapter 2-18

cautions xx

components list 2-2

Configuration Lockout screen 3-10

configuration screens

- configuration lockout 3-10
- Contrast 3-8
- Language 3-10, 3-11

configuring

- Port A parameters 4-9
- the AgGPS 114 receiver 4-1
 - using the AgRemote keypad 4-2

connecting external devices

- optional Ag Leader power/data cable 2-14
- optional CASE AFS power/data cable 2-11
- optional GreenStar data cable 2-12
- optional RDS cable 2-17
- optional Windows CE cable 2-18, 2-19
- optional Windows CE with

cigarette power adapter
cable 2-18

Contrast screen 3-8

copyrights ii

D

datums

- NAD-83 1-6
- WGS-84 1-6

DGPS accuracy 1-4

DGPS Configuration screens 4-3

- DGPS Source 4-3
- Easy Satellite DGPS Configuration 4-5
- OmniSTAR Activation 4-7
- Racal Solution 4-8
- Satellite Baud 4-7
- Satellite Frequency 4-6

DGPS Source screen 4-3

Differential GPS (DGPS) positioning 1-3

disclaimer of warranty iii

document conventions xix

E

Easy Satellite DGPS Configuration screen 4-5

elevation mask 1-5

enhancements 2-2

Everest technology 1-9

F

fast rate 1-9

Fast Rate Output G-1
Flash Loader 100 E-1
 connecting to software E-2
 running E-4
 using E-3
front panel
 using 3-1

G

getting started 3-1
GGA sentence A-2, D-11
GLL sentence A-2, D-12
GP Talker ID D-5
GPS error
 sources of 1-3
GRS output sentence D-13
GSA sentence A-2, D-14, D-16
GST output sentence D-15
GSV sentence A-2, D-16
guidelines
 installation 2-4

H

Home screen 3-4

I

II Talker ID D-5
input
 ASCII, RTCM, TSIP 1-12
inspecting shipment 2-2
installation
 guidelines 2-4
 choosing a location 2-4

considering environmental
 conditions 2-5

K

keypad actions 3-2

L

Language screen 3-10, 3-11
LC Talker ID D-5
LG Talker ID D-5
limitation of liability iii
limited warranty
 firmware iv
 hardware iv
 software iv

M

manual organization xvi
measuring GPS accuracy 1-6
 receiving satellite DGPS (AgGPS
 114 only) 1-6
mounting
 antenna 2-6
 receiver 2-6
MSS sentence A-2
multipath 1-3, 1-5

N

NAD 83 1-6
navigation map
 AgGPS Firmware v1.40 I-1

NMEA-0183

latitude and longitude values D-6

other values D-6

sentences

ALM D-9

checksum values D-4

description D-1

field formats D-5

fields D-5

GGA A-2, D-11

GLL A-2, D-12

GSA A-2, D-3, D-14, D-16

GSV A-2, D-16

MSS A-2

null fields D-5

PTNLAG001 D-23

PTNLDG D-26

PTNLEV D-24

PTNLID D-25

RMC A-2, D-18

sample structure D-3

structure D-2

summary D-7

summary of supported
sentences D-7

symbols and delimiters D-3

VTG A-2, D-16, D-20

ZDA A-2, D-2, D-22

Talker ID Codes

GP D-5

II D-5

LC D-5

LG D-5

time values D-6

notes xx

number

visible satellites 1-4

number of visible satellites 1-4

O

OmniSTAR 1-7

OmniSTAR Activation screen 4-7

organization

of manual xvii

other information xvii

World Wide Web (WWW)

site xvii

output

1 pps 1-12

RTCM, TSIP, NMEA, 1 pps 1-12

overview 1-1

AgGPS 114 receiver 1-1, 5-1

P

PDOP 1-4

performance characteristics

GPS channels A-2

physical characteristics

AgGPS 114 receiver A-1, B-1

pin-out diagrams

dual interface cable C-4

general description C-1

overview C-1

tables C-1

Port A

NMEA 2

configuration 4-12

parameters

configuring 4-9

Port parameters

configuring

- input 4-10
- position dilution of precision 1-4
- PTNLAG001 sentence D-23
- PTNLDG sentence D-26, D-27, D-29
- PTNLEV sentence D-24
- PTNLID sentence D-25

R

- Racal Solution screen 4-8
- Racal-LandStar 1-7
- RAIM
 - GAST output sentence D-15
 - GRS output sentence D-13
- reader comment form xix
- receiver connections 1-11
- receiver defaults B-1
- receiver enhancements 1-9, 2-2
 - Everest technology 1-9
 - Fast Rate 1-9
- receiving DGPS
 - satellite 1-6
- reporting shipping problems 2-3
- revision notice iii
- RMC sentence A-2, D-18
- routing, connecting
 - antenna cable 2-8

S

- Satellite Baud screen 4-7
- Satellite Frequency screen 4-6
- scope xv
- screens
 - configuration
 - NMEA 1 4-11

- Port A 4-9
- Port A input 4-10
- Home 3-4
- status
 - viewing 3-2
- selective availability (S/A) 1-3
- shipping
 - reporting problems 2-3
- signal-to-noise ratio (SNR) 1-5
- sources of electrical interference 2-7
- sources of GPS error 1-3
 - atmospheric conditions 1-3
 - multipath 1-3
 - receiver (electronic) noise 1-3
 - selective availability 1-3
- specifications A-1
- standard features 1-8

T

- Talker ID D-5
- technical assistance xviii
- tips xx
- trademarks iii
- troubleshooting 5-1
 - checking for antenna cable
 - failure 5-4
 - choosing an antenna location 5-4
 - increasing GPS accuracy 5-1
 - intermittent GPS loss 5-3
 - losing configuration settings when
 - receiver is powered off 5-5
 - overview 5-1
 - power lines and strong magnetic
 - fields 5-3
 - reducing engine noise 5-4
 - restoring receiver to factory

defaults 5-6
satellite DGPS works in some
places but not others 5-5
verifying unit is outputting NMEA
messages 5-5
troubleshooting guides
GPS reception 5-9
GPS reception - using a yield
monitor 5-11
OmniSTAR 5-14
Racal-LandStar 5-16
system hardware and power
check 5-7

output sentence D-21

Z

ZDA sentence A-2, D-2, D-3, D-21,
D-22

U

using the front panel 3-1

UTC

GRS sentence D-13

GST sentence D-15

V

viewing screen status 3-2

VTG sentence A-2, D-16, D-20

W

warnings xx

WGS-84 1-6

World Wide Web (WWW) site xvii

www.trimble.com xvii

X

XTE

Reader Comment Form

AgGPS 114 Operation Manual
P/N: 38201-00

March 2000
Revision A

We appreciate your comments and suggestions for improving this publication. Contributors of particularly helpful evaluations will receive a thank-you gift.

I use the following Trimble product _____
for _____

Please circle a response for each of the statements below:

	1 = Strongly Agree	2 = Agree	3 = Neutral	4 = Disagree	5 = Strongly Disagree
The manual is well organized	1	2	3	4	5
I can find the information I want.	1	2	3	4	5
The information in the manual is accurate.	1	2	3	4	5
I can easily understand the instructions.	1	2	3	4	5
The manual contains enough examples.	1	2	3	4	5
The examples are appropriate and helpful.	1	2	3	4	5
The layout and format are attractive and useful.	1	2	3	4	5
The illustrations are clear and helpful.	1	2	3	4	5
The manual is:			too long	just right	too short

Please answer the following questions:

Which sections do you use the most? _____

What do you like best about the manual? _____

What do you like least about the manual? _____

Optional

Name _____

Company _____

Address _____

Telephone _____ Fax _____

Please mail to the local office listed on the back cover or to Trimble Navigation Limited, Precision Agricultural Systems, 645 North Mary Avenue, Post Office Box 3642, Sunnyvale, CA 94088-3642. All comments and suggestions become the property of Trimble Navigation Limited.

